



Super Series

Owner's Handbook

Assistance

Retailer Network

The Authorised McLaren Retailer network is constantly expanding and a full list with contact details can be found at:

www.retailers.mclaren.com

In the event of an emergency, call your local emergency telephone number.

For non-emergency assistance, contact your nearest McLaren retailer.

Contact details for McLaren Client Services can be found at:

<https://cars.mclaren.com/contact-us>

Australia only: If you have been unable to obtain assistance using the number(s) listed for towing/roadside assistance, or the dealer is unable to provide towing/roadside assistance, please call 1800 626 768.



Contents

1.01 Before You Drive

2.01 Driving Controls

3.01 Instruments

4.01 Central Display

5.01 Comfort and Convenience

6.01 Maintaining Your McLaren

7.01 Vehicle Data and Glossary

8.01 Conformity Information

Introduction

Introduction

Please read this information to familiarise yourself with your McLaren and its features before you drive. This provides the necessary information for you to get the optimum benefit and enjoyment from your McLaren.

This publication describes all options and features available for the McLaren Super Series. Certain descriptions, including those for display and menu functions, may not apply to your vehicle due to model variant, country specifications, optional equipment or the fitment of McLaren approved accessories.



NOTE: The images shown in this publication may not exactly reflect your unique vehicle.

The documents supplied with your McLaren are an integral part of the vehicle. Ensure that you pass them onto the new owner if you sell the vehicle.

The information is divided into specific sections, to assist in finding the particular information you require:

Before You Drive

Details the settings you need to make in the cockpit to ensure you are fully prepared and have safe and easy access to all controls before driving.

Driving Controls

This section contains detailed information regarding the equipment and driving controls fitted to your McLaren and how to use those controls to best effect during a journey.

Instruments

This section contains information on the Folding Driver Display, including information on how to operate features of the McLaren Infotainment System (MIS).

Central Display

This section contains information on the McLaren Infotainment System (MIS), including information on how to view and change vehicle settings.

Comfort and Convenience

Contains information on those systems and features which make the cockpit a pleasant environment in which to spend time.

Maintaining your McLaren

Information on maintaining your McLaren is located here. Also included is advice on using your McLaren in winter weather and if you choose to drive your vehicle abroad, what to do if something should go wrong and how to manage any possible problems which arise as a result. Information on fuses, lights and what to do if you experience a puncture.

Vehicle Data and Glossary

Refer to this section when you need information regarding the fluid specifications and quantities that are required for the various systems on your McLaren, or when you need to know a specific piece of data relating to your McLaren or its performance.

The technical glossary contains a brief explanation of some of the more complex systems fitted to your McLaren. Your McLaren retailer will be able to assist should you need more information.

Index

The table of contents and the index will help you find information quickly, when you need it.

Introduction

Information about this document

McLaren is constantly updating its vehicles to meet and exceed the latest technologies. McLaren therefore reserves the right to introduce changes in design, equipment and technical features at any time.

© McLaren Automotive Limited.

This publication must not be reproduced, translated or reprinted, in whole or in part, without written permission from McLaren Automotive Limited.

The equipment fitted to your McLaren may vary from the images shown depending on vehicle and market specification. Your McLaren may vary from the images shown depending on vehicle and market specification.

All information, illustrations and specifications in our applications are based on data available and are correct at the time of issue. The availability of options may vary from market to market due to local restrictions and regulations. Some illustrations in these applications may not necessarily reflect the specifications or options available in your local market and may show optional equipment.

The specifications contained in these applications are for information purposes only and McLaren Automotive reserves the right to change product specifications at any time without notice or incurring obligation. For full specification details and information on standard and optional equipment, please consult your McLaren retailer.

This vehicle may be covered by patents. See cars.mclaren.com/patents.

Printed in United Kingdom, 14QB816CP.

Electronic user manual

If your vehicle is fitted with an electronic user manual, the Owner's Handbook is available on the Central Infotainment Touchscreen.

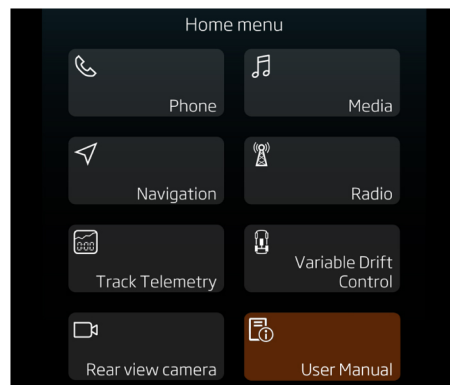

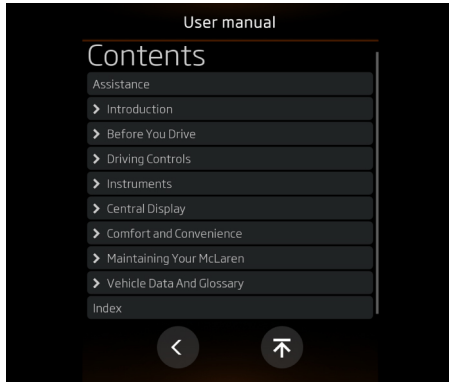

To access the manual, select User manual from the McLaren Infotainment System (MIS) Home screen.

Introduction



Select the required language, then select a topic from the contents page.

 The home icon appears at the top and bottom of each page. Selecting the home button will return you to the main contents page.

 The icons can be used to navigate to the previous or next topic as required.



Select 'Related Topics' to quickly access the other information within the current section.

 This icon can be used like a web browser back button, to go back to the previous view.

 This icon can be used to return to the main contents page.

Symbols

You will find the following symbols in this Owner's Handbook. These symbols are intended to give you an instant visual message on what type of information is being displayed.

Warnings	
	A warning draws your attention to activities that could cause injury or death.
Notes	
	Notes draw your attention to activities that contain possible risks to your McLaren, provide advice that you may find useful, or give additional information regarding a particular subject.
Environmental notes	
	Environmental notes give you tips on minimising the impact that you and your vehicle have on the environment.

Introduction

Operating safety

 **WARNING:** The electronic systems fitted to your McLaren interact with each other. Tampering with these systems could cause malfunctions in other interconnected systems. Such faults could seriously endanger the operational safety of your McLaren and your own safety. **Additional work or modifications made to the vehicle, which have been carried out incorrectly can also affect its operating safety.**

Vehicle use

Observe the following when using your McLaren:

- The safety notes throughout this information
- Road traffic laws and regulations

 **WARNING:** There are various warning labels attached to your McLaren. These are intended to make you and others aware of various risks. Do not remove any warning labels from the vehicle.

If you remove these warning labels, you or others may not then be aware of dangers, which may result in an injury.

Ground clearance

 **WARNING:** Damage to the underside of the vehicle may occur when approaching steep inclines or declines.

Drive with care when:

- approaching kerbs.
- approaching steep inclines.
- departing steep declines.
- driving on rough roads.
- driving in areas where traffic calming measures have been deployed.
- driving in any other environment where sudden change of road surface height or elevation are encountered such as car parks.

See Vehicle dimensions, page 7.07.

Track driving

To achieve optimum performance and reliability, it is important to ensure the following preconditions are met before attempting to drive your vehicle on a track:

- Engine oil is at normal operating temperature
- Engine oil level shows 3, 4, 5 or 6 green segments, see Checking the engine oil, page 6.04
- Engine coolant is at normal operating temperature
- Tyres should not exceed the safe operating temperatures

 **NOTE:** Before you use your vehicle on a track, consult your McLaren retailer. McLaren recommend that your vehicle is inspected before and after track use.

 **NOTE:** Always drive within your limits and the limits of the vehicle.

Introduction

Cooling down

McLaren recommend that you take time to cool the vehicle down during track driving, due to the high temperatures that may be generated by the brakes and transmission which could affect performance. Time should be taken to drive the vehicle at a slower speed without using hard braking or carrying out excessive gear changes, this uses the airflow to cool the vehicle.

McLaren recommend that time is allowed for your vehicle to return to normal operating temperatures before leaving the track.



NOTE: When stopping the vehicle directly after performance driving, McLaren recommend that the ignition is not immediately switched off or parking brake applied. McLaren recommend that the engine is left to idle prior to the ignition being switched off.



NOTE: Please refer to your Service and Warranty Guide for track and competition use implications.

Stored data

There are a number of components in your vehicle which collect data and store it temporarily or permanently. This technical data provides information relating to areas such as the condition of the vehicle, any events which have taken place and any malfunctions your vehicle may be experiencing or has experienced in the past.

These include, for example:

- operating conditions of system components, e.g. fluid levels.
- the vehicle's status messages and those of its individual components, e.g. 'Windscreen washer fluid low'.
- malfunctions and defects in important system components, e.g. 'Light switch fault'.
- vehicle reactions and operating conditions in special driving situations, e.g. air bag deployment.
- ambient conditions, e.g. outside temperature.

This data is of an exclusively technical nature and can be used to:

- assist in recognising and rectifying faults and defects.
- analyse vehicle functions, e.g. after an accident.
- optimise vehicle functions.

The data cannot be used to trace the vehicle's movements.

When your vehicle is serviced, technical information can be read from the vehicle including:

- repair service history.
- warranty events.
- quality assurance.

This information can be read by employees of the service network (including manufacturers) using special diagnostic testers. More detailed information can be obtained from it, if required.

After a fault has been rectified, the information is deleted from the fault memory or is continually overwritten.

When operating the vehicle, situations may occur where technical data, in connection with other information, could be traced to a person.

Examples include:

Introduction

- accident reports.
- damage to the vehicle.
- witness statements.

McLaren will not access your behaviour related information about a crash event or share it with others except:

- with the consent of you or, if the vehicle is leased, of the lessee.
- in response to an official request of police or similar government office.
- as part of the manufacturer's defence in case of legal proceedings.
- as required by law.

In addition, McLaren may use the collected or received diagnostic data:

- for McLaren research needs.
- to make it available for research needs where appropriate confidentiality is maintained and need is shown.
- to share summary data which is not tied to a specific vehicle with other organisations for research purposes.

Before You Drive

Opening and Closing.....1.04

General.....	1.04
Opening a door.....	1.06
Locking a door.....	1.07
Mislock.....	1.08
Individual settings.....	1.09
Locking and unlocking from inside.....	1.09
Opening a door from inside.....	1.09
Closing a door.....	1.10
Automatic locking.....	1.11
Service cover - 720S and 765LT Coupe.....	1.11
Service covers - 720S and 765LT Spider.....	1.13
Front luggage compartment.....	1.14
Retractable Roof - Spider models.....	1.15
Backlight - Spider models	1.19
Tonneau Cover - Spider models	1.20

Stowage.....1.23

Stowage - Spider models.....	1.23
------------------------------	------

Anti-Theft System.....1.24

Alarm system.....	1.24
Immobiliser.....	1.24
Tow-away protection.....	1.25
Interior motion sensor.....	1.25

Seats.....1.27

Safety.....	1.27
Manual seats.....	1.28
Race seats.....	1.29

Electric seats.....	1.29
LT Super-Lightweight CF Seat.....	1.33

Steering Wheel and Steering Column.....1.34

Manual steering wheel adjustment.....	1.34
Electric steering wheel adjustment.....	1.34
Horn.....	1.36

Occupant Safety.....1.37

Seat belts.....	1.37
Supplementary restraint system (SRS).....	1.39
Child passengers.....	1.43

Mirrors.....1.46

Safety.....	1.46
Interior mirror.....	1.46
Exterior mirrors.....	1.46

Lighting.....1.48

Exterior lighting.....	1.48
Light switch.....	1.50
Main beam headlamps.....	1.51
Headlamps.....	1.51
Daytime running lamps.....	1.52
Rear fog lamp.....	1.52
Direction indicators.....	1.53
Hazard warning lamps.....	1.53
Parking lights.....	1.54

Washers and Wipers.....1.55

Windscreen wipers.....	1.55
------------------------	------

Before You Drive

Vehicle Lift.....1.57
Vehicle lift.....1.57

Before You Drive

Opening and Closing

General

The vehicle can be unlocked or locked either by using the keyless entry feature, or by pressing the appropriate button on the key fob.

The keyless entry feature requires the key fob to be within 1.2 m (3 ft 11 in) of the sensors.

Provided that the engine is not running, the vehicle can be locked irrespective of the electrical status, see Vehicle electrical status, page 2.02.

Keyless entry

Keyless entry allows the user to unlock and disarm the vehicle by simply opening the door when the key fob is within 1.2 m (3 ft 11 in) of the sensors. The key fob needs only to be on the user's person or in a non-metallic container such as a bag. It does not need to be exposed or handled.

Five sensors detect where the key fob is around the vehicle.

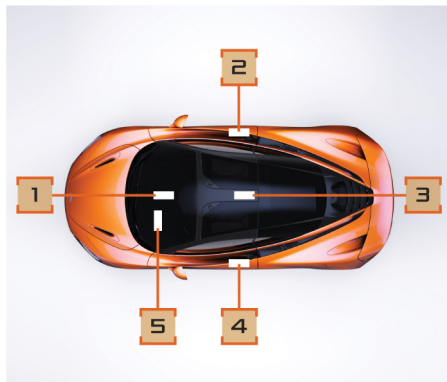

Right-hand drive models

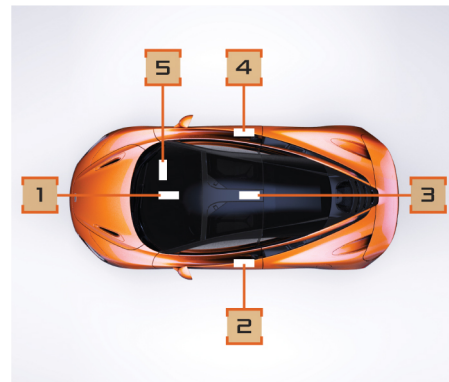

Left-hand drive models

1. Front in vehicle sensor
2. Driver's door sensor
3. Rear in vehicle sensor
4. Passenger's door sensor
5. Passenger's footwell sensor

Key fob entry

Your McLaren includes two remote control key fobs. The key fob allows you to remotely lock and unlock the vehicle.

Before You Drive Opening and Closing

i NOTE: To prevent theft, only use the key fob in the immediate vicinity of the vehicle.

The key fob locks and unlocks the following:

- The doors
- The luggage compartment
- The fuel filler flap
- The centre console stowage compartment - except 765LT



To unlock the vehicle, using the key fob, press the unlock button. The front, rear and side direction indicators (market specific) flash twice and the anti-theft alarm system will be deactivated.

The unlock button operation changes depending whether the Driver's door or Both doors is selected in the vehicle settings, see Door unlock, page 4.20.

⚠ WARNING: The key fob allows the engine to be started and is also used to activate other features on the vehicle. Take the key fob with you, every time you leave the vehicle.

i NOTE: Do not expose the key fob to high levels of electromagnetic radiation. Doing so may cause it to function incorrectly. For example close proximity to laptops, tablets, personal media players, or mobile phones.

Unlock Button	Outcome
Single Press	If Both doors is selected, a single press of the button unlocks both doors. If Driver's door is selected, a single press of the button unlocks the driver's door. A second press (after a pause) unlocks the passenger's door.
Double Press	If Both doors is selected, a double press of the button unlocks both doors and unlatches the driver's door. If Driver's door is selected, a double press of the button will unlock and unlatch the driver's door only.

Before You Drive

Opening and Closing

Stowing the key fob

For security, it is recommended that the key fob stays on your person when you are in the vehicle. If, however, you wish to stow the key fob within the vehicle, ensure that it is not left in plain view.

i NOTE: If the message 'Key not found within vehicle' appears on the Folding Driver Display, reposition the key fob until it is detected.

i NOTE: Do not stow the key fob in the centre console stowage compartment, in the cup holders, in the stowage nets between the seats, in the door stowage compartments, or on the shelf immediately behind the seats as the system may not detect its presence and the engine will not start.

Discharged battery

If you experience a fully discharged battery, the vehicle can still be opened using the mechanical key, see Unlocking - discharged battery, page 6.27.

Opening a door



1. Press the button (1) firmly to unlock and unlatch the door.

i NOTE: The keyless entry feature requires the key fob to be within 1.2 m (3 ft 11 in) of the sensors.

⚠ **WARNING: Always stand to the rear of the door before opening it, as the opening action may cause injury. The speed that the door opens will be affected by ambient temperature.**

i NOTE: Because the door opens outwards and then upwards, ensure sufficient side and overhead clearance before opening a door, see Vehicle dimensions, page 7.07.

2. If keyless entry is used, the front, rear and side direction indicators (market specific) will flash twice, and the anti-theft alarm system will be deactivated.
3. The door latch will then release, the mirrors will unfold if folded and the door will be allowed to be partially raised before it automatically swings outwards and upwards.

i NOTE: On Spider models, when the door is opened, the window will lower slightly. It will raise to the closed position once the door is shut. If the window does not lower, for example, due to a discharged battery or freezing temperatures, take care when opening and closing the door. Do not force the door during opening or closing, as this could lead to the door seals or window becoming damaged.

Before You Drive Opening and Closing

- i** NOTE: A sustained, long press and hold on the unlock button will automatically lower the windows. The windows will continue to lower until the unlock button is released or the windows reach a predetermined level. See Hot Evac, page 5.06.
- i** NOTE: If the vehicle is unlocked using the key fob but the doors or luggage compartment are not opened, the vehicle will relock after 30 seconds.

Locking a door



1. Close the door. See Closing a door, page 1.10.
2. To lock the vehicle using the key fob, press the lock button. The front, rear and side direction indicators (market specific) flash in a rapid, circular sequence around the vehicle. The anti-theft alarm system is activated.

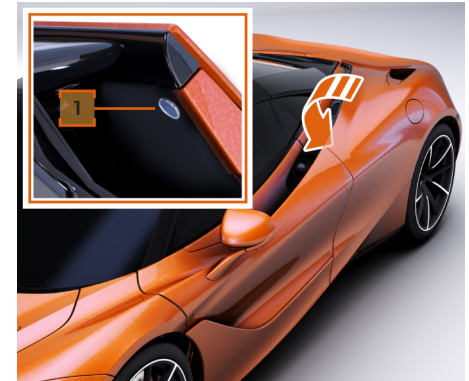

3. If using the keyless entry feature, press the touch sensitive switch (1) located within the side duct.
- i** NOTE: The keyless entry feature requires the key fob to be within 1.2 m (3 ft 11 in) of the sensors.
 - i** NOTE: The lock switch will recognise a single press.
 - i** NOTE: The lock switch is touch activated. There is no mechanical travel or audible feedback when pressed.

Before You Drive

Opening and Closing

i NOTE: A sustained, long press and hold on the lock switch will automatically raise the window(s). The window(s) will continue to raise until fully closed.

4. The direction indicators flash to indicate that the anti-theft alarm system is activated.

i NOTE: On Spider models, when the door is opened the door glass will lower slightly to avoid contact with other parts of the vehicle. When the door is closed the glass will raise to the closed position automatically. If for any reason the door glass does not raise it is likely that the system has sensed a “trap” event. This can be caused by debris in the glass channel or misalignment of the glass. Ensure there are no obvious signs of debris in the glass channel, and hold the lock button. The glass will raise providing the door is correctly closed and there are no obstructions preventing it raising. If the glass does not close, or the glass repeatedly fails to automatically raise, contact your McLaren retailer.

Mislock



If either the doors or the luggage compartment lid are left open, or the key fob is still inside the vehicle, the horn will sound indicating mislock when an attempt to lock the vehicle is made.

Check that the doors, the luggage compartment lid, the service cover and the tonneau cover (Spider models only) are all closed and that the roof is fully open or fully closed (Spider models only), then relock the vehicle.

i NOTE: The vehicle can be locked/alarmed with the luggage compartment open. A long tone sounds to alert you to this condition, and differs to the short tone sounded for door open/key fob in vehicle mislock. The luggage compartment will become alarmed as soon as the luggage compartment lid is closed. This allows you to connect a McLaren supplied battery charger to the charging point in the luggage compartment whilst leaving the rest of the vehicle locked.

Before You Drive Opening and Closing

Individual settings

If you frequently travel without passengers, you can change the locking system so that only the driver's door is unlocked, see Automatic door locking, page 4.19.

If only the driver's door has been configured to unlock, the passenger's door can only be unlocked by either pulling the passenger's door internal handle, pressing the unlock button on the key fob again or by unlocking the vehicle from the central locking button located on the dashboard.

Locking and unlocking from inside



1. Press the central locking button to lock the vehicle, the light in the button will illuminate to indicate that the vehicle is locked. A door can be opened from inside the vehicle.
2. Press the central locking button again to unlock the vehicle and the light in the button will be extinguished.

Opening a door from inside

A door can be opened from inside the vehicle at any time, even if it has been locked. Open the doors only if the vehicle is stationary and road and traffic conditions permit.

i NOTE: Because the door opens outwards and then upwards, ensure sufficient side and overhead clearance before opening a door.



Pull door handle upwards, in direction of arrow, and push the door outwards until the opening mechanism takes over. The door will then swing outwards and upwards automatically.

Before You Drive Opening and Closing

i NOTE: Unlocking the vehicle using the door handle while the key fob is not within the vehicle will activate the anti-theft system and may cause the alarm to sound.

Closing a door

Push/pull the door downwards and ensure that it latches securely.

⚠ WARNING: Keep hands and other objects clear of the door edge when closing. This is particularly important for vehicles fitted with soft close latches as the door will automatically continue to the fully closed position when the first catch has engaged. There is no anti-trap feature preventing the door closing if an item or body part is trapped between the door and the door aperture, serious injury and vehicle damage may occur.

i NOTE: Do not force close the door, the door aperture or door seals could be damaged.

On Spider models, if the window does not close, this may be due to an anti-trap event. Try one of the following:

- Reopen and close door
- Lock vehicle using the lock switch in the side duct



In the event of continuous anti-trap events, press the lock switch (1) for a few seconds. The window will continue to raise until you remove your finger from the lock switch. Only attempt this if the above methods do not resolve the problem.

i NOTE: Do not force the door closed, the door seals or window could be damaged.

Before You Drive

Opening and Closing

Automatic locking

The doors and the luggage compartment lock automatically after the vehicle has driven away.

i NOTE: The doors unlock automatically in an accident if the force of the impact exceeds a predetermined level.

The automatic locking function is selectable in the vehicle settings section of the Central Infotainment Touchscreen, see Automatic door locking, page 4.19.

If automatic locking is ON, the interior central locking button will illuminate once the vehicle locks on drive away.

Service cover - 720S and 765LT Coupe

Removal

! WARNING: The service cover can be very hot and there is a risk of severe burns. Only remove the service cover once it has cooled down.

! WARNING: The exhaust tail pipes can be very hot and there is a risk of severe burns. Only remove the service cover from the side of the vehicle.

! WARNING: There is a risk of injury if the service cover is removed, even when the engine is not running. Engine components become very hot and there is a risk of severe burns. The engine ignition system carries a high voltage. Never touch ignition system components; ignition coils, ignition wiring (spark plug connections).

! WARNING: If the engine is stopped due to the Eco Start-Stop system, the engine may restart without warning.

1. Remove the service cover release tool from the tool kit. See Luggage compartment equipment, page 6.12.

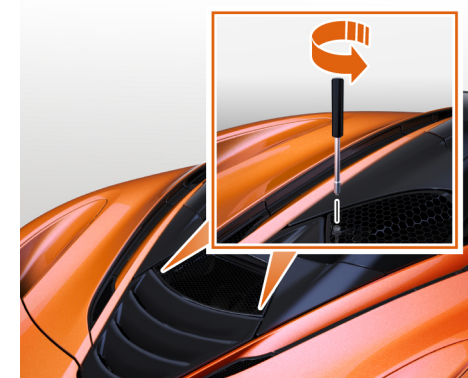

2. Insert the service cover release tool into each fixing located underneath the lower corners of the service cover. Rotate each fixing 90° anti-clockwise to release both sides of the service cover.

Before You Drive Opening and Closing

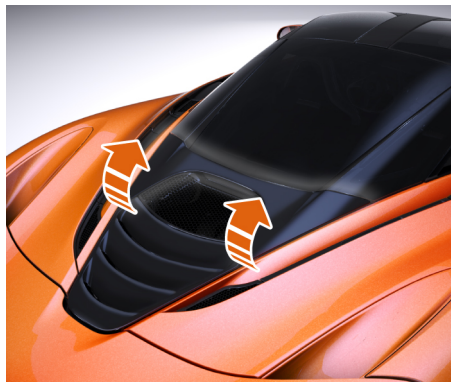

3. From the side of the vehicle, grasp the two rear edges of the service cover and rotate the service cover upwards towards the rear windscreen to remove.

i **NOTE:** Place the service cover inside the vehicle to avoid the risk of damage.

See Engine oil, page 6.04.

See Coolant, page 6.07.

Installation

⚠ **WARNING:** The exhaust tail pipes can be very hot and there is a risk of severe burns. Only install the service cover from the side of the vehicle.

1. Position service cover centrally on the back of the vehicle.

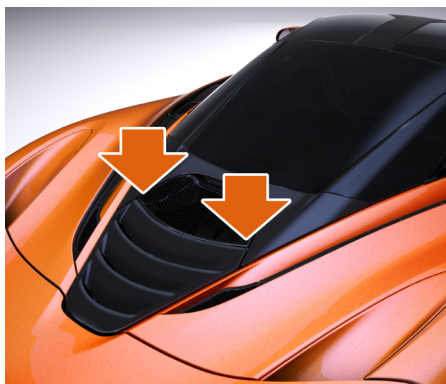

2. Apply pressure to the service cover as shown. Positive clicks will be heard when the two fixings engage.





3. Insert the service cover release tool into each fixing located underneath the lower corners of the service cover. Push down and rotate each fixing clockwise until a positive click of engagement is heard to latch both sides of the service cover.
4. Ensure service cover is secure once installed.

Before You Drive

Opening and Closing

Service covers - 720S and 765LT Spider

Removal

-  **WARNING:** The service covers can be very hot and there is a risk of severe burns. Only remove the service covers once they have cooled down.
-  **WARNING:** The exhaust tail pipes can be very hot and there is a risk of severe burns. Only remove the service covers from the side of the vehicle.
-  **WARNING:** There is a risk of injury if the service covers are removed, even when the engine is not running. Engine components become very hot and there is a risk of severe burns. The engine ignition system carries a high voltage. Never touch ignition system components; ignition coils, ignition wiring (spark plug connections).
-  **WARNING:** If the engine is stopped due to the Eco Start-Stop system, the engine may restart without warning.

1. Fully open the tonneau cover.

See Tonneau Cover - Spider models , page 1.20.



2. From the side of the vehicle, grasp the front edge of the left-hand service cover and pull upwards to release it.
 3. Rotate the service cover upwards towards the centre of the vehicle to remove.
-  **NOTE:** Place the service cover inside the vehicle to avoid the risk of damage.
4. Repeat steps 2 and 3 to remove the right-hand service cover.

-  **NOTE:** The engine oil filler can be accessed by removing the right-hand service cover only. Both service covers and the rear deck vent must be removed to access the coolant filler.

See Engine oil, page 6.04.

See Coolant, page 6.07.

Installation

-  **WARNING:** The exhaust tail pipes can be very hot and there is a risk of severe burns. Only install the service covers from the side of the vehicle.

1. Position service cover on the side of the vehicle.
2. Applying even pressure, push the service cover down, ensuring the fixings engage.
3. Repeat steps 1 and 2 to install the other service cover, if it has been removed.
4. Ensure both service covers are secure once installed.
5. Close the tonneau cover.

See Tonneau Cover - Spider models , page 1.20.

Before You Drive

Opening and Closing

Front luggage compartment

i NOTE: The luggage compartment will only open if the vehicle is stationary and neutral is selected. A message will display on the Folding Driver Display if the luggage compartment is open when pulling away.

i NOTE: When the luggage compartment is unlatched or open, gear selection will be inhibited. Press and hold D or R for 5 seconds to override this and select a gear if there is a need to manoeuvre the vehicle.

! **WARNING: Only manoeuvre the vehicle at low speed if the luggage compartment is open or unlatched as the drivers' view may become obscured.**

Opening



Press the luggage release button on the key fob, the luggage compartment will fully unlock and open slightly.



Alternatively, press the dashboard button to fully unlock and slightly open the luggage compartment.

Lift the front of the luggage compartment lid, the gas struts will support it in the fully open position.

Closing

Pull the luggage compartment lid down firmly and ensure that it is latched securely.

i NOTE: Do not leave the key fob in the luggage compartment, as the vehicle may lock, and you may be locked out of the vehicle.

Before You Drive Opening and Closing

i NOTE: If the vehicle had previously been locked, it will still be locked and the direction indicators will flash as the lid closes.

The luggage compartment will become alarmed as soon as the luggage compartment lid is closed.

i NOTE: The vehicle can be locked/alarmed with the luggage compartment open. This will allow you to charge the battery while leaving the rest of the vehicle locked. A long tone sounds to alert you to this.

Retractable Roof - Spider models

The retractable roof comprises of a single lightweight panel which, when operated, folds swiftly beneath the tonneau panel located behind the cockpit.

The roof can be operated using the switch on the centre console or the key fob.

The roof can be operated at speeds up to 31 mph (50 km/h).

! **WARNING: Do not operate the roof while driving over rough road surfaces. The roof system could be damaged.**

! **WARNING: Do not place any objects between the moving parts of the roof. Make sure any occupants or bystanders are clear of the roof during operation. Operation of the roof may cause personal injury or damage to components.**

! **WARNING: Ensure any items in the tonneau stowage area are correctly stored, as directed by the warning label. The roof system and/or the backlight glass could be damaged.**

! **WARNING: To avoid damaging the operating mechanism and the vehicle interior, carefully remove surface water, ice or snow before operating the roof.**

The roof must only be operated if any items in the tonneau stowage area are correctly stored, as directed by the warning label.



i NOTE: Do not sit, stand or place any load on the backlight interior trim panel.

i NOTE: If the engine is stopped with the roof open, it is possible to close the roof before the vehicle goes to sleep to leave it secure.

Before You Drive Opening and Closing

- i** NOTE: If you experience any problems with the roof, contact your McLaren retailer immediately.

Roof Operating Temperature

Minimum ambient operating temperature	-20°C (-4°F)
Maximum ambient operating temperature	85°C (185°F)

- i** NOTE: Roof opening operation is inhibited when operated below the minimum ambient operating temperature.

Opening

1. The vehicle must be awake with key present.

- i** NOTE: Operation of the roof will be halted whilst the engine is cranking.



2. Press and hold the switch to open the roof. If the switch is released, the roof will stop until the switch is pressed again.

- i** NOTE: If the tonneau cover has been opened at any time while the roof is closed, the message 'Confirm Tonneau Empty' will be displayed on the Folding Driver Display.

3. Check any items in the tonneau storage area are correctly stored, as directed by the warning label. Press OK on the menu stalk, once you have confirmed this.



4. Press and hold the switch until the roof is fully open (stowed).

- i** NOTE: When the roof starts to move, the tonneau cover will open and the backlight glass will drop slightly. The message 'Roof Operation In Progress' will appear on the Folding Driver Display.

Before You Drive

Opening and Closing

- Once the roof is fully open (stowed), the tonneau cover will close and the backlight glass will return to an aero position to reduce wind buffeting in the cockpit. The message 'Roof Open' will appear on the Folding Driver Display. An audible tone will confirm that the roof cycle is complete.
- If the switch is held in the down position after the operation has completed, the windows and backlight will open fully. If the switch is released, the windows and backlight will stop until the switch is pressed again.
- If the vehicle speed rises above 31 mph (50 km/h) while the roof is being operated, roof operation is paused. The message 'Reduce Vehicle Speed, Release and Re-press Button For Roof Operation' will appear on the Folding Driver Display.
- Reduce the vehicle speed to below 31 mph (50 km/h) and release the switch. The message 'Continue Roof Cycle' will appear on the Folding Driver Display. Press the switch again to continue desired roof cycle.

Closing

- The vehicle must be awake with key present.

i NOTE: Operation of the roof will be halted while the engine is cranking.



- Pull and hold the switch until the roof is in the fully raised (closed) position. If the switch is released, the roof will stop until the switch is pulled again.
- If the vehicle speed rises above 31 mph (50 km/h) while the roof is being operated, roof operation is paused. The message 'Reduce Vehicle Speed, Release and Re-press Button For Roof Operation' will appear on the Folding Driver Display.

- Reduce the vehicle speed to below 31 mph (50 kph) and release the switch. The message 'Continue Roof Cycle' will appear on the Folding Driver Display.
- Pull the switch to continue closing until the roof and tonneau are fully closed and latched. The windows and backlight glass will raise to the fully closed position. An audible tone will confirm that the roof cycle is complete.
- Continuing to hold the switch after the roof cycle is complete will raise the windows and backlight glass. If the switch is released, the windows and backlight will stop until the switch is pressed again.

Remote opening with the key fob

⚠ WARNING: Do not place any objects between the moving parts of the roof. Make sure any occupants or bystanders are clear of the roof during operation and ensure line of sight is maintained when using the remote opening function. Operation of the roof may cause personal injury or damage to components.

Before You Drive Opening and Closing

The roof can be opened remotely using the key fob, when the vehicle is in a locked or unlocked state.



1. Press and hold the unlock button to open the roof. If the button is released, the roof will stop until the button is pressed again.

i NOTE: If the vehicle is locked, the front, rear and side direction indicators (market specific) will flash twice, but the vehicle will remain locked.



2. Press and hold the button until the roof is fully open (stowed).
3. Once the roof is fully open (stowed), the tonneau cover will close and the backlight glass will return to an aero position to reduce wind buffeting in the cockpit. An audible tone will confirm that the roof cycle is complete.

i NOTE: If the vehicle is locked, the front, rear and side direction indicators (market specific) will flash twice, but the vehicle will remain locked.

4. If the button is held down after the operation has completed, the windows and backlight will open fully. If the button is released, the windows and backlight will stop until the button is pressed again.

Remote closing with the key fob

⚠ **WARNING:** Do not place any objects between the moving parts of the roof. Make sure any occupants or bystanders are clear of the roof during operation and ensure line of sight is maintained when using the remote closing function. Operation of the roof may cause personal injury or damage to components.

The roof can be closed remotely using the key fob, when the vehicle is in a locked or unlocked state.

Before You Drive Opening and Closing



1. Press and hold the lock button to close the roof. If the button is released, the roof will stop until the button is pressed again.

i NOTE: If the vehicle is locked, the front, rear and side direction indicators (market specific) will flash twice, but the vehicle will remain locked.

2. Press and hold the lock button to continue closing until the roof and tonneau are fully closed and latched. The windows and backlight glass will raise to the fully closed position. An audible tone will confirm that the roof cycle is complete.

i NOTE: If the vehicle is locked, the front, rear and side direction indicators (market specific) will flash twice, but the vehicle will remain locked.

3. Continuing to press and hold the lock button after the roof cycle is complete will raise the windows and backlight glass. If the button is released, the windows and backlight will stop until the button is pressed again.

Backlight - Spider models

Lower the backlight, with the roof open, to obtain additional air flow around the cockpit. Raise the backlight to an aero position to reduce wind buffeting in the cockpit.

i NOTE: It is only possible to operate the backlight if the vehicle is awake with the key present.



The backlight switch is located on the centre console.

Before You Drive

Opening and Closing

- i** NOTE: If you experience any problems with the backlight, contact your McLaren retailer immediately.

Opening

1. The vehicle must be awake with the key present.

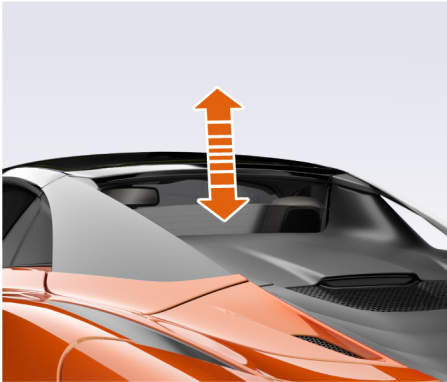

2. Press and hold the backlight switch to lower the backlight to the desired position.

- i** NOTE: Do not fully open the backlight when it is raining or snowing, as water could enter the cabin area and affect electrical components.

Closing

1. The vehicle must be awake with the key present.

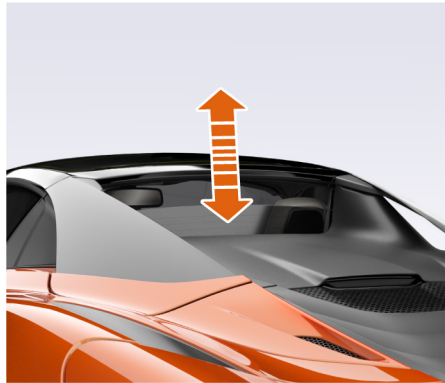

2. Pull and hold the backlight switch to raise the backlight until the backlight is in the desired position.

- i** NOTE: If the vehicle is stopped with the backlight open, you are able to close the backlight before the vehicle goes to sleep to leave it secure.

Tonneau Cover - Spider models

The tonneau cover is the panel behind the cockpit. The tonneau cover can be opened and closed and allows access to the area below.

The retractable roof is stowed in the area underneath the tonneau cover when the roof has been lowered. The tonneau cover is then closed.

- i** NOTE: If you experience any problems with the tonneau cover, contact your McLaren retailer immediately.

Opening

1. The vehicle must be awake with key present.

- !** **WARNING: Do not place any objects between the moving parts of the tonneau. Make sure any occupants or bystanders are clear of the tonneau during operation. Operation of the tonneau may cause personal injury or damage to components.**

Before You Drive Opening and Closing

- i** NOTE: Do not operate the tonneau cover whilst loading/unloading of the tonneau area is taking place. The vehicle will remain awake for a maximum of fifteen minutes while the tonneau is open.
- i** NOTE: Access to the tonneau storage area can only be made using the tonneau open/close buttons on the driver's door switch panel.
- i** NOTE: The key must be within range of the driver's door to enable tonneau control.



2. Press and hold the button on the rear edge of the driver's door until the tonneau cover is fully open.
- i** NOTE: The tonneau cover cannot be opened if the roof is open.
3. Check any items in the tonneau stowage area are correctly stored, as directed by the warning label. Press OK on the menu stalk, once you have confirmed this.



4. If the vehicle is driven whilst the tonneau cover is open, the message 'Tonneau Cover Open' will appear on the Folding Driver Display, accompanied by an audible alert.

Closing



! **WARNING:** Ensure that no one can be trapped as you close the tonneau cover.



1. Press and hold the button on the rear edge of the driver's door until the tonneau cover is fully closed.
- i** NOTE: The tonneau cover can be closed for up to 15 minutes once it has been opened whilst the ignition is off. If this time has elapsed, switch the ignition on again to close the tonneau cover.

Before You Drive

Opening and Closing

-  NOTE: The message 'Tonneau Operation In Progress' will appear on the Folding Driver Display.
-  NOTE: The tonneau area will be alarmed when the vehicle is locked.

Before You Drive Stowage

Stowage - Spider models

The area underneath the tonneau cover can be used for stowing small items.

Ensure any items in the tonneau stowage area are correctly stored, as directed by the warning label.

 **WARNING:** Do not place loose items in the tonneau area. This could lead to damage to the roof system and/or the backlight glass.

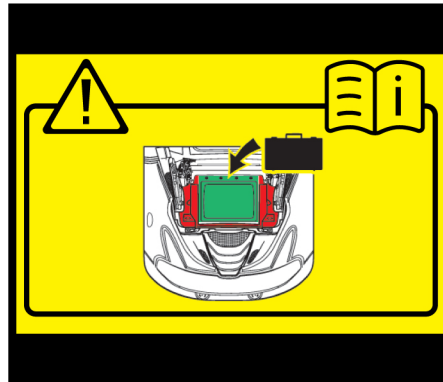

 **NOTE:** Do not store any of the following in the tonneau storage area:

- hazardous and/or volatile compounds or liquids
- heavy and/or sharp objects
- foods and/or liquids affected by heat
- fragile items or items which are easily breakable

Before You Drive

Anti-Theft System

Alarm system

A visual and audible alarm is triggered if the alarm system is armed and any of the following are opened:

- A door
- The luggage compartment lid
- The tonneau cover (Spider models only)

i NOTE: The alarm remains triggered even if you close the open aperture. To silence the alarm, unlock the vehicle.

The alarm system also incorporates the following features:

- Tow-away protection
- Interior motion detection sensor
- Centre console stowage compartment status detection - except 765LT

i NOTE: The centre console stowage compartment must be closed for the interior motion sensor or the Auto Alarm to become armed - except 765LT.

Arming the alarm system

Lock the vehicle (using the keyless system or the key fob). The anti-theft alarm system will be armed after approximately 5 seconds.



The light in the central locking button will illuminate for approximately 60 seconds after locking the vehicle, the light will continue to flash beyond this time.

Disarming the alarm system

Unlock the vehicle (using the keyless system or the key fob), the alarm will disarm and the light in the central locking button will stop flashing.

Immobiliser

The immobiliser prevents your McLaren from being started by an unauthorised person.

The vehicle is automatically immobilised when it senses that there is no key fob present in the vehicle.

Remobilisation occurs when a key fob is sensed inside the vehicle.

i NOTE: Immobilisation will only occur if the engine is not running.

Before You Drive

Anti-Theft System

Tow-away protection

Tow-away protection is designed to prevent any attempt to steal the vehicle by suspended tow or lifting onto a trailer.

The alarm is triggered if the vehicle is raised or tilted in any way.

Tow-away protection is armed approximately 30 seconds after the vehicle has been locked and is disarmed when the vehicle is unlocked.

Disabling tow-away protection



1. To disable tow-away protection, switch off the ignition, open the driver's door and press the button on the rear edge of the driver's door. The light in the switch will illuminate to indicate that tow-away protection has been disabled.

- i** **NOTE:** You cannot disable tow-away protection if the ignition is switched on.
2. Close the driver's door and lock the vehicle (using the keyless system or the key fob). Tow-away protection remains disabled until you unlock the vehicle.

Interior motion sensor

The alarm is triggered if your vehicle is locked and movement is detected inside, e.g. if someone breaks a window or reaches into the vehicle through an open window.

The interior motion sensor is armed approximately 30 seconds after the vehicle has been locked and is disarmed when the vehicle is unlocked.

- i** **NOTE:** To prevent false alarms close the roof (Spider models only) and windows when leaving the vehicle and do not hang anything on the interior mirror.

Before You Drive Anti-Theft System

Disabling the interior motion sensor

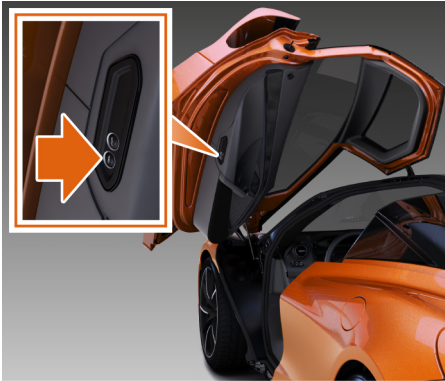

1. To disable the interior motion sensor, switch off the ignition, open the driver's door and press the button on the rear edge of the driver's door. The light in the switch will illuminate to indicate that the interior motion sensor has been disabled.

i NOTE: You cannot disable the interior motion sensor if the ignition is switched on.

2. Close the driver's door and lock the vehicle (using the keyless system or the key fob). The interior motion sensor remains disabled until you unlock the vehicle.

Before You Drive Seats

Safety

 **WARNING:** Adjust the driver's seat when the vehicle is stationary. You may not be able to observe road and traffic conditions and you could lose control of the vehicle as a result of the seat moving. You could therefore cause an accident.

 **WARNING:** The seats can be moved even without a key fob in the vehicle. Do not leave children unattended in the vehicle, they could be injured if a seat is moved accidentally.

 **WARNING:** Ensure that no one can become trapped as the seat moves. To reduce the risk of injuries in the event of an accident, observe the following:

- All vehicle occupants must select a seat position that allows the seat belt to be worn correctly, but is as far away from the front air bags as possible. The position of the driver's seat must allow the driver to drive the vehicle safely. The distance from the driver's seat to the pedals must be such that the driver can fully depress the pedals. The distance between the driver's chest and the centre of the air bag cover must be more than 25 cm (10 in). The driver's arms should be slightly bent when holding the steering wheel.
- Vehicle occupants must always wear their seat belt correctly.
- Position the passenger's seat as far back as is comfortable.

 **WARNING:** McLaren does not recommend the use of child seats in this vehicle, but if you choose to do so, please follow the guidelines below:

- Children under 1.5 m (4 ft 11 in) tall or younger than 12 years of age must be secured in a suitable child restraint. Please refer to current national and local laws for specific requirements.
- If you are using a child restraint on the passenger's seat, move the seat as far back as possible.

Before You Drive Seats

Manual seats

Manual seat forward and rearward adjustment



Lift the lever, move the seat to the desired position and release the lever to lock the seat.

⚠ WARNING: Ensure the seat is locked in position before driving.

i NOTE: Ensure that there are no items of luggage in the footwell or behind, underneath or to the side of the seats. This may lead to the seats being damaged.

Manual seat backrest rake adjustment

⚠ WARNING: To minimise the risk of injury, position the backrest as close as possible to vertical.

i NOTE: Do not recline the seat backrest so that it repeatedly contacts the rear bulkhead as this could lead to damage over time.



Lift the lever, move the seat backrest to the position required, and release the lever.

Manual seat height adjustment



Press the switch up or down until the seat reaches the desired height.

i NOTE: Height adjustment is only available on the driver's seat.

Before You Drive Seats

Race seats

Seat forward and rearward adjustment



i NOTE: It is only possible to adjust the forward and rearward position of the seat.

To adjust the seat, lift the lever and slide the seat to the desired position, ensuring you can comfortably reach all pedals and are able to move them through their full travel.

! **WARNING:** Ensure the seat is locked in position before driving.

i NOTE: Ensure that there are no items of luggage in the footwell or adjacent to the seats as this may lead to the seats being damaged or not getting full adjustment.

Seat height and tilt adjustment

For seat height and tilt adjustment, contact your McLaren retailer.

! **WARNING:** Seat height adjustment should only be carried out by your McLaren retailer.

Electric seats

Electric seat adjustment

The seat adjustment switches are on the side of the seat base and can be used when the vehicle is in any Awake mode, see Vehicle electrical status, page 2.02.

i NOTE: Ensure there are no items of luggage in the footwell or behind, beneath or to the side of the seats, or the seats may be damaged.

Forward and rearward adjustment

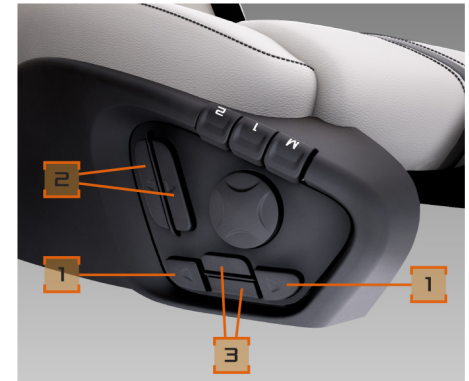

Before You Drive Seats

Press the switches (1) until the seat reaches the desired position.

Electric seat backrest rake adjustment

⚠ WARNING: To minimise the risk of injury, position the backrest as close as possible to vertical.

i NOTE: When reclining the backrest, the seat base will automatically move forward, depending on its position relative to the rear bulkhead. If the seat base is moved backwards when the backrest is fully reclined, the backrest will automatically raise to prevent contact with the rear bulkhead.

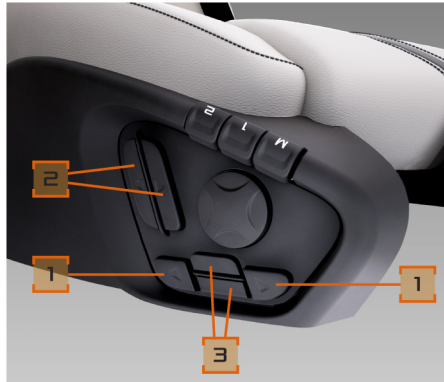

Press the switches (2) until the backrest is in the required position.

⚠ WARNING: Ensure there are no items beneath the passenger's seat or the occupant classification system may not function correctly.

Electric seat height adjustment

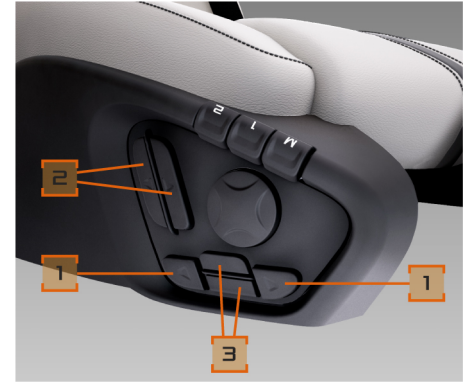

Press the switches (3) until the seat reaches the desired height.

Before You Drive Seats

Electric seat lumbar adjustment

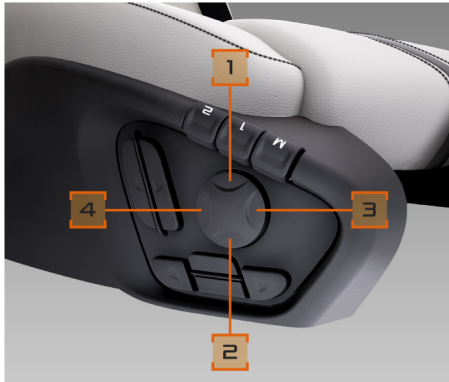

Press (1) to raise or (2) to lower the position of the lumbar support.

Press (3) to inflate or (4) to deflate the lumbar support.

Storing a memory position

Specific seat, exterior mirror, and steering wheel positions can be stored for up to two drivers.

- i** NOTE: Exterior mirror and steering wheel positions can only be stored or recalled using the driver's memory buttons.

- i** NOTE: Steering wheel position can only be stored or recalled if an electric steering column is fitted.

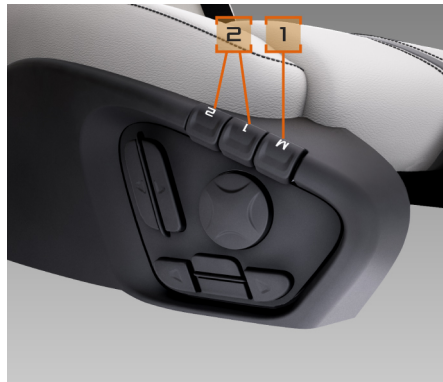

Set the seat, mirrors, and steering wheel to the desired positions; see Electric steering wheel adjustment, page 1.34, Exterior mirrors, page 1.46.

Press and hold the memory set button (1) and then simultaneously press one of the memory position buttons (2) to store the setting.

Recalling a memory position

- ⚠** **WARNING:** Only recall a seat, mirror, and steering wheel position, when the vehicle is stationary. You may not be able to observe road and traffic conditions. This could lead you to lose control of the vehicle which may result in an accident.

- i** NOTE: Exterior mirror and steering wheel positions can only be stored or recalled using the driver's memory buttons.
- i** NOTE: Steering wheel position can only be stored or recalled if an electric steering column is fitted.

Before You Drive Seats

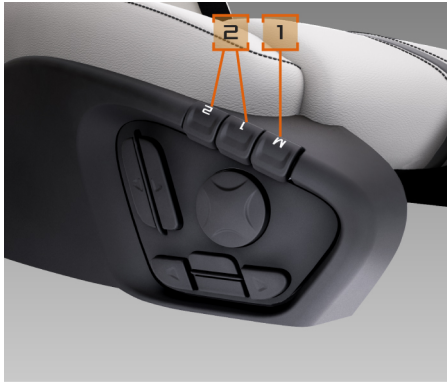

Press the button (2) where the required setting is stored, and hold until the seat, exterior mirrors and steering wheel have completed their adjustment.

Comfort exit

⚠ WARNING: Ensure that no one can become trapped as the seat moves.

When comfort entry/exit is active, the driver's seat will move fully rearwards and to its lowest position and the steering wheel will move inwards and to its highest position when the engine is off and the driver's door is opened.

This assists exit from the vehicle. To switch the feature on or off, see Comfort entry/exit, page 4.18.

i NOTE: The steering wheel will only change position if an electric steering column is fitted.

Comfort entry

After entering the vehicle, you can return the driver's seat and steering wheel to their most recent position using the control stalk on the left of the steering column.

i NOTE: The steering wheel will only change position if an electric steering column is fitted.

The function will only be available when 'Comfort Entry available Pull left stalk to activate Press OK to cancel' is displayed on the Folding Driver Display.

The vehicle must be Awake with ignition off, the driver's door closed, and comfort entry/exit ON.

1. Pull the control stalk towards you once to initiate the comfort entry function.

2. If at any point you wish to cancel the function, operate the control stalk or open the driver's door. A message 'Comfort Entry returning Operate stalk or open door to abort' will appear on the Folding Driver Display.

i NOTE: This function will only return the seat and steering wheel to the position they were in prior to the comfort entry/exit function being used. It will not use any of the memory positions, unless the previous position was one of the stored memory positions.

3. If the seat or steering wheel are manually adjusted before the stalk is used, the function will be lost and will not be available until the next time comfort entry/exit function is used.

i NOTE: Cancel the comfort entry/exit function by starting the engine, pressing a seat or steering column switch, or by operating the control stalk on the left of the steering column while the seat is returning to position.

Before You Drive Seats

4. If the comfort entry/exit function is cancelled, it will not be possible to return the seat and steering wheel to their previous positions using this function. The message on the Folding Driver Display will disappear and the control stalk will return to its normal use. The function will be available when comfort entry/exit is next used.
5. Once the seat and steering wheel have returned to their previous positions, the message on the Folding Driver Display will disappear and an audible alert will confirm that the process has been completed.

Heated seats

Heated seats can be accessed using the climate control screen on the Central Infotainment Touchscreen. See Heated seats, page 5.10.

- i** NOTE: The heated seat function is only available when the engine is running.

LT Super-Lightweight CF Seat

Seat forward and rearward adjustment



- i** NOTE: It is only possible to adjust the forward and rearward position of the seat.

To adjust the seat, lift the lever and slide the seat to the desired position, ensuring you can comfortably reach all pedals and are able to move them through their full travel.

- !** **WARNING:** Ensure the seat is locked in position before driving.

- i** NOTE: Ensure that there are no items of luggage in the footwell or adjacent to the seats as this may lead to the seats being damaged or not getting full adjustment.

Seat height and tilt adjustment

For seat height and tilt adjustment, contact your McLaren retailer.

- !** **WARNING:** Seat height adjustment should only be carried out by your McLaren retailer.

Before You Drive

Steering Wheel and Steering Column

Manual steering wheel adjustment

⚠ WARNING: Only adjust the steering wheel position when the vehicle is stationary. You may not be able to observe road and traffic conditions. This could lead to you losing control of the vehicle which may result in an accident.

The steering wheel can be adjusted for height and reach.

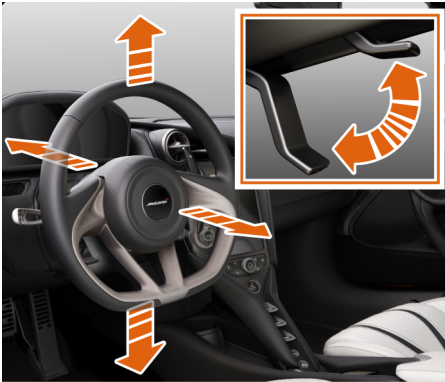

Push the lever (highlighted) downwards and position the steering wheel so that:

- your arms are slightly bent when you hold the wheel.
- you can move your legs freely.
- you can see all the information on the Folding Driver Display clearly.

Pull the lever up to secure the steering wheel. Ensure the lever is locked before driving.

Electric steering wheel adjustment

⚠ WARNING: Only adjust the steering wheel position when the vehicle is stationary. You may not be able to observe road and traffic conditions. This could lead to you losing control of the vehicle which may result in an accident.

The steering wheel position may be adjusted for height and reach using the column control switch when the vehicle is in any Awake mode, see Vehicle electrical status, page 2.02.

The column control switch is located on the left-hand side of the steering column.

Before You Drive

Steering Wheel and Steering Column



1. Height: Raise
2. Height: Lower
3. Reach: Away
4. Reach: Towards

Moving the column control switch in directions 1 & 2 adjusts the steering wheel height, raising or lowering the wheel's position.

Moving the column control switch in directions 3 & 4 adjusts the steering wheel reach, moving it closer or further away.

i NOTE: The column control switch will only adjust the steering wheel in one direction at a time.

Using the column control switch, position the steering wheel so that:

- your arms are slightly bent when you hold the wheel.
- you can move your legs freely.
- you can see all the information on the Folding Driver Display clearly.

Automatic steering wheel adjustment

If your vehicle is equipped with electric seats, the electric steering wheel position is stored when the seat and mirror positions are stored. See Storing a memory position, page 1.31.

! **WARNING: Ensure that your hands are kept clear of the wheel and column as the steering wheel moves.**

i NOTE: Any automatic movement can be cancelled with any input from the column control switch.

Comfort entry/exit

When comfort entry/exit is active, the steering wheel and column will move fully inwards (away from the driver) and to its highest position when the engine is off and the driver's door is opened.

To switch the feature on or off, see Comfort entry/exit, page 4.18.

You can return the steering wheel and column to its most recent position using the control stalk on the left of the steering column. See Storing a memory position, page 1.31.

! **WARNING: Ensure that your hands are kept clear of the wheel and column as the steering wheel moves.**

i NOTE: Any automatic movement can be cancelled with any input from the column control switch.

Before You Drive

Steering Wheel and Steering Column

Horn

Press the centre of the steering wheel to operate the horn.

 **NOTE:** The horn can be operated when the ignition is switched off.

Before You Drive

Occupant Safety

Seat belts

Seat belts and child restraint systems are the most effective means of restraining vehicle occupants from impact forces, which minimises the danger of injury from interior impacts and the effects of whiplash.

-  **WARNING: A seat belt which is not worn, worn incorrectly, or has not been engaged fully in the seat belt buckle, cannot perform its intended function. To avoid injuries, ensure that all vehicle occupants wear their seat belt correctly at all times. Ensure that the belt:**
- is routed as low as possible across your pelvic area, i.e. across your hip joints and not across your abdomen.
 - fits closely.
 - is not twisted.
 - is routed across the middle of your shoulder.
 - lies flat across the mid point of the collar bone between the neck and shoulder.
 - fits closely across your pelvis by pulling the shoulder belt upwards.

Do not secure any objects with a seat belt if the seat belt is being used by a vehicle occupant.

Avoid wearing bulky clothing.

Do not route the belt across sharp edged or fragile objects especially if these are on or in your clothing. The seat belt could be damaged and you could be injured.

Only one person should use each seat belt at any one time.

Never allow children to travel on the lap of another occupant.

Children under 1.5 m (4 ft 11 in) tall or younger than 12 years of age must be secured in a suitable child restraint. Follow the manufacturer's instructions when installing child restraint systems. Please refer to current national and local laws for specific requirements.

 **WARNING: Pregnant women should wear a seat belt to ensure maximum safety of mother and unborn child. Position the lap belt across the hips, beneath the abdomen and position the shoulder belt between the breasts and to the side of the abdomen. Ensure the belt is not slack or twisted.**

 **WARNING: The seat belt only provides its intended degree of protection if the seat backrest is positioned close to vertical, and the occupant is sitting upright.**

 **WARNING: The seat belt cannot perform its function correctly if the seat belt or buckle becomes excessively dirty or damaged. Ensure the belt latch engages the buckle fully. Check the seat belts regularly to ensure that they are not damaged, or routed over sharp edges and are not trapped. The belt could tear in an accident, causing injury to occupants.**

Before You Drive Occupant Safety

Have seat belts checked if the belts have been damaged or subjected to a heavy load. Work on the seat belts should only be carried out by your McLaren retailer.

Wearing a seat belt



1. Ensure that you are seated comfortably and the controls are within easy reach.
2. Grasp the seat belt latch and pull across the body, ensuring that the belt lies flat across the mid point of the collar bone between the neck and shoulder, then across the chest and pelvis.

3. With the belt correctly positioned insert the latch into the buckle and press until a click is heard to confirm engagement.

Check engagement by attempting to pull the latch from the buckle.

Seat belt tensioners

The seat belts incorporate belt tensioners. Belt tensioners apply tension to the seat belts in an accident, pulling them tight against the occupant.

⚠ WARNING: Do not insert the belt latch into the passenger's seat belt buckle if the passenger's seat is unoccupied. The belt tensioners could be triggered in an accident.

⚠ WARNING: Belt tensioners do not correct an incorrect seating position or incorrectly worn seat belts. Belt tensioners do not pull occupants back towards the backrests.

The belt tensioner will be triggered for each seat belt, provided the belt latch is engaged in the seat belt buckle, if a head-on or rear-end collision occurs and the vehicle decelerates or accelerates rapidly.

If the belt tensioners are triggered, a bang will be heard, a small amount of dust may be released and the supplementary restraint system warning light will illuminate.

⚠ WARNING: Once triggered (or if you are unsure if they have triggered) you MUST not drive the vehicle. Contact your nearest McLaren retailer immediately.

Belt force limiters

The seat belts incorporate belt force limiters. Belt force limiters are tuned to the front air bags and gradually release the tension being applied to the belts during an impact, reducing the force exerted on occupants.

Seat belt warning light

 The seat belt warning light on the Folding Driver Display and a warning tone reminds vehicle occupants to fasten their seat belts. The seat belt warning light extinguishes and the warning tone ceases when the driver and passenger have fastened their seat belt.

Before You Drive

Occupant Safety

Supplementary restraint system (SRS)

Air bag system

Your McLaren is equipped with the following air bags:

- Driver's front air bag in the steering wheel
- Passenger's front air bag in the upper area of the dashboard
- Side head air bags in the doors

⚠ WARNING: Correct operation of the air bags can only occur if the steering wheel, the passenger's air bag cover and the door trim are not covered.

⚠ WARNING: Air bags are not a substitute for correctly worn seat belts, they enhance the level of occupant protection offered by seat belts.

⚠ WARNING: To reduce the risk of injuries in the event of an accident, observe the following points:

- Ensure that the driver's chest is at least 25 cm (10 in) from the air bag cover.

- Do not lean forward over the dashboard while the vehicle is in motion.
- Do not rest your feet on the dashboard.
- Only hold the steering wheel by the outside of the rim. You could be injured if the air bag deploys and you are holding the inside of the steering wheel.
- Occupants, particularly children, must not lean on the doors from inside the vehicle.
- Ensure that there are no other occupants and the deployment area of the air bags.
- Because of the high speed at which air bags deploy, there is a risk of injuries caused by an inflating air bag.

Air bag replacement

⚠ WARNING: McLaren recommend that air bags are replaced every 15 years to prevent air bags from not firing due to component operating life.

Air bag system modification

If it is necessary to modify the air bag system to accommodate a person with disabilities, please contact your nearest McLaren retailer. For more information on McLaren retailers, please refer to your Service and Warranty Guide.

Front air bags

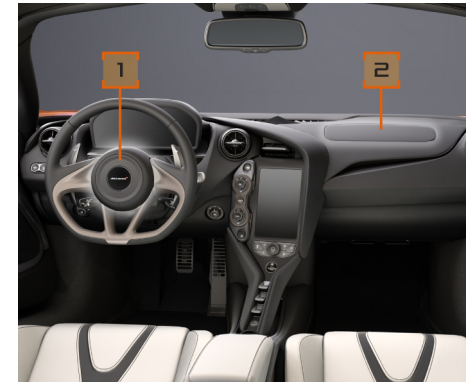

The driver's front air bag (1) deploys in front of the steering wheel and the passenger's front air bag (2) deploys in front of and above the dashboard.

Before You Drive Occupant Safety

The front air bags are deployed if the system determines they can offer additional protection for occupants against head and chest injuries.

- i** NOTE: The passenger's front air bag is only deployed if the PASSENGER AIR BAG OFF warning light on the overhead console is NOT illuminated, see Occupant classification system - passenger's seat, page 1.40.

Side head air bags

- ⚠** WARNING: To reduce the risk of injury to occupants if a side head air bag is deployed, ensure that:

- there are no other objects between the vehicle occupants and the deployment area of the air bags.
- no accessories are attached to the doors.
- no heavy or sharp objects are left in the pockets of clothing.
- occupants, particularly children, must not lean on the doors from inside the vehicle.



The side head air bags are located in the upper area of each door panel, and are deployed if the system determines they can offer additional protection for the head of the occupant on the side of the vehicle on which the impact occurs.

- i** NOTE: The passenger's side head air bag is only deployed if the passenger's seat is occupied.

Occupant classification system - passenger's seat

The system can determine if the passenger's seat is occupied using a capacitance mat fitted in the seat base, and by checking the seat belt buckle engagement on the passenger's seat belt. The system will deactivate the passenger's front air bag for children in child seats and unoccupied passenger's seat ensuring air bag deployment for adults.



The status of the air bags is indicated by the PASSENGER AIR BAG OFF warning light on the overhead console.

Before You Drive

Occupant Safety

The PASSENGER AIR BAG OFF warning light illuminates when the ignition is switched on and extinguishes after 5 seconds.

The warning light will remain illuminated if the passenger's seat is unoccupied or if a child seat is fitted.

i NOTE: The PASSENGER AIR BAG OFF warning light is always illuminated unless the passenger's seat is occupied by an adult.

If the PASSENGER AIR BAG OFF warning light is illuminated, the passenger's front air bag is not active. The side head air bag and the belt tensioner on the passenger's side remain active even if the PASSENGER AIR BAG OFF warning light is illuminated.

! WARNING: If the PASSENGER AIR BAG OFF warning light is not illuminated when the child seat is fitted, the passenger's air bag is not deactivated. The child could be seriously injured if the passenger's air bag inflates.

! WARNING: To ensure that the occupant classification system functions correctly, McLaren recommend that objects are not placed under a seat. McLaren also recommend that additional materials are not applied such as a blanket, cushion, or aftermarket equipment such as a seat cover, heater, or massager. These items can seriously affect how well the occupant classification system operates. McLaren recommend that aftermarket equipment such as covers, heaters, and massagers are NOT used.

! WARNING: Any electronic devices that are either active or connected to the 12 V accessory socket should not be placed on the passenger's seat. They can affect how the occupant classification system operates.

! WARNING: The occupant classification system may become affected if any form of liquid (inclusive of rain) is spilled onto the passenger's seat. If the PASSENGER AIR BAG OFF warning light is not illuminated when the seat is unoccupied, do not install a child restraint or allow anyone to occupy the seat. Please contact your nearest McLaren retailer at your earliest convenience.

! WARNING: Do not place sharp objects onto the passenger's seat. These may damage the occupant classification system if they puncture the seat cushion.

Before You Drive Occupant Safety

 **WARNING: To ensure that the occupant classification system functions correctly, never place objects (e.g. a cushion) under the child restraint system. The entire base of the child restraint system must be in contact with the seat at all times. If a child restraint system is not fitted correctly it may not provide the intended degree of protection in the event of an accident and may cause injuries.**

Air bag deployment

In the event of a collision, the air bags are deployed by the supplementary restraints system to protect the vehicle occupants. The system can control the number of air bags deployed and partially or fully inflate the air bags depending on the severity of the collision to provide the best possible protection to the vehicle occupants.

The system uses sensors to rapidly evaluate the collision severity and the number of vehicle occupants. Once all these factors are known, the system will then deploy the necessary air bags and regulate the inflation pressure in the impact zone to ensure the occupant's safety.

After an accident, the air bags begin to depressurise almost immediately after the inflation process has taken place. The gas used to inflate the air bags escapes through vents in the air bag and this helps reduce the occurrence of major impact injuries to the occupants.

An air bag slows down and restricts the movement of the vehicle occupant reducing the load on the body, but is not a substitute for a correctly worn seat belt.

 **WARNING: If the air bags are deployed, a bang will be heard and a small amount of fine powder may be released. The noise will not damage your hearing and the powder does not constitute a health hazard nor does it imply that a fire has broken out. This powder could cause short term breathing difficulties for persons suffering from asthma or other respiratory conditions. To prevent breathing difficulties, leave the vehicle as soon as possible or open a window.**

 **WARNING: After an air bag has been deployed, air bag parts are hot, do not touch them. Have the air bags replaced at your McLaren retailer.**

Out of position (OOP)

The air bag system in your McLaren has been tested for the correct small child out of position (OOP) operation. OOP can occur if a small child is incorrectly positioned in the passenger's seat in the event of a collision in which the air bags are deployed.

Supplementary restraint system (SRS) warning light

 The supplementary restraint system performs a self-test at regular intervals when the ignition is switched on and the engine is running.

The warning light on the Folding Driver Display illuminates when the ignition is switched on and extinguishes 5 seconds after the engine is started.

 **WARNING: Contact your McLaren retailer immediately should any of the following occur:**

- The warning light does not illuminate when you switch on the ignition
- The light does not extinguish 5 seconds after the engine is running
- The light illuminates again, after the engine has started

Before You Drive Occupant Safety

Safety features

If you are unfortunate enough to be involved in an accident, the following events will occur to assist you and any recovery personnel:

- The doors will unlock
- The hazard warning lights will switch on
- The interior lighting will switch on

In some instances, the fuel system will also be switched off.

Child passengers



WARNING: Do not leave children unsupervised in the vehicle even if they are secured in a child restraint. Children could injure themselves on parts of the vehicle, open a door and be seriously or even fatally harmed by prolonged exposure to heat or cold.

If children open a door, they could cause injury to others in doing so or get out of the vehicle and possibly injure themselves or they could be injured by a passing vehicle.

Do not expose the child restraint system to direct sunlight. The metal parts of the child restraint system could burn the child.

Do not carry heavy or hard objects inside the vehicle unless they are secured.

An unsecured or incorrectly positioned load increases the risk of injury to the child during sharp braking, a sudden change of direction or an accident.

Child restraint system

McLaren does not recommend the use of child seats in this vehicle, but if you choose to do so, please follow the guidelines below:

Secure any child under 1.5 m (4 ft 11 in) tall or younger than 12 years of age travelling in the vehicle in an appropriate category restraint according to their weight. Contact your McLaren retailer for advice.

Please refer to current national and local laws for specific requirements.



Before You Drive Occupant Safety

⚠ WARNING: Never secure a rearward facing child restraint system on the passenger's seat if the passenger's front air bag is active. The status is indicated by the PASSENGER AIR BAG OFF indicator.



⚠ WARNING: If the PASSENGER AIR BAG OFF indicator does not illuminate, do not use a rearward facing child restraint system on the passenger seat. You may use a forward-facing child restraint system on the passenger's seat. The warning label on the passenger's side is there to remind you of this.

⚠ WARNING: If a forward facing child seat is fitted to the passenger's seat, make sure that the passenger's seat is fully rearwards and is positioned at the lowest height. A manual passenger's seat does not have height adjustment.

⚠ WARNING: If the child restraint system has not been fitted correctly, the child cannot be restrained in an accident or sudden braking and could be injured. When fitting a child restraint system, observe the manufacturer's instructions on the correct use of the child restraint.

KISI child restraint function

Your McLaren is fitted with a KISI system which is an automatic locking seat belt on the passenger's side designed to temporarily lock the seat belt to securely hold the child restraint in the passenger's seat.

1. Extend the passenger's seat belt fully. The KISI system only engages when the seat belt is fully extended.

i NOTE: If the vehicle is parked on a hill, the inertia lock may prevent the seat belt from extending. If this occurs, release the seat belt slightly and continue to extend the seat belt carefully to avoid the engagement of the inertia lock.

2. Pass the seat belt through the child restraint as described by the child restraint manufacturer and engage the belt latch in the buckle.
3. Adjust the belt so that the lower section is tight against the restraint and allow the upper section to retract. The KISI system will click as the belt retracts.
4. When the seat belt has retracted as far as possible, pull on the upper section to check that the seat belt has locked.

Before You Drive Occupant Safety

 NOTE: The KISI system will disengage when the seat belt has fully retracted and can then be worn as a normal seat belt. Once the KISI system has unlocked, it will be necessary to fully extend the seat belt to engage the KISI system the next time a child restraint is used.

Before You Drive Mirrors

Safety

 **WARNING:** Before driving, adjust all mirrors to give the best possible view of road and traffic conditions.

Interior mirror



The automatic dimming function of the interior mirror is activated or deactivated by pressing the switch (2) on the bottom of the mirror. The indicator light (1) will illuminate when automatic dimming is active.

When activated, the interior mirror will automatically dim when bright light is detected by the light sensor (3).

If reverse gear is selected or if ambient light levels are high, the automatic dimming function will be deactivated.

Exterior mirrors

 **WARNING:** In some markets, the exterior mirrors have convex glass fitted. This type of mirror enlarges the field of vision, but reduces the size of the image. This means that objects are closer than they appear. To avoid misjudging the distance to vehicles travelling behind and perhaps causing an accident, check the actual distance of the vehicle, before changing direction.

The exterior mirrors control is located on the dashboard between the steering wheel and the centre console.

Before You Drive Mirrors

Adjusting mirrors

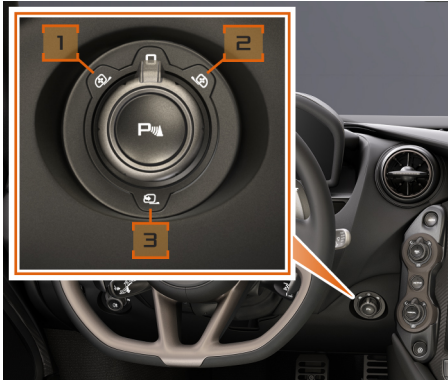

1. Switch the ignition on.
2. Rotate the control to the left (1) to adjust the left-hand mirror or to the right (2) to adjust the right-hand mirror.
3. Move the control up, down, left and right to adjust the mirror to the desired position.

Exterior mirror fold

1. Switch the ignition on.
2. Rotate the control to position (3) to fold the mirrors.

3. To unfold the mirrors rotate the control away from position (3).

i NOTE: If the switch remains in position (3) the mirrors will be folded until the switch is moved.

Exterior mirror automatic fold

The exterior mirrors can be set so that they fold automatically when the vehicle is locked. Unfolding occurs as a door is opened, not when the vehicle is unlocked. See Automatic mirror folding, page 4.19.

Mirror dipping in reverse

The exterior mirrors can be set to dip when reverse is engaged. This provides a view of the ground to the rear of the vehicle. See Reverse mirror dip, page 4.18.

Heated mirrors

Exterior mirrors are heated when the heated rear window is in operation, and the engine is running. They are also heated when the ambient temperature is below 5°C (41°F).

Before You Drive Lighting

Exterior lighting

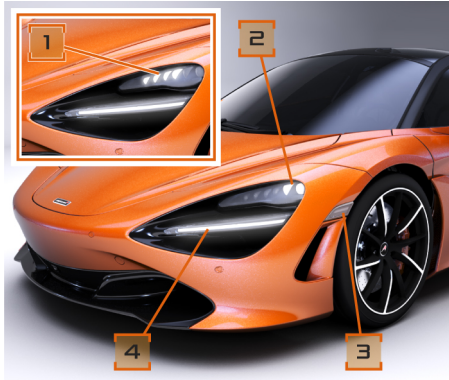

1. Headlamp main beam
2. Headlamp dipped beam
3. Side direction indicator
4. Direction indicator/Daytime running lamp/Sidelamp

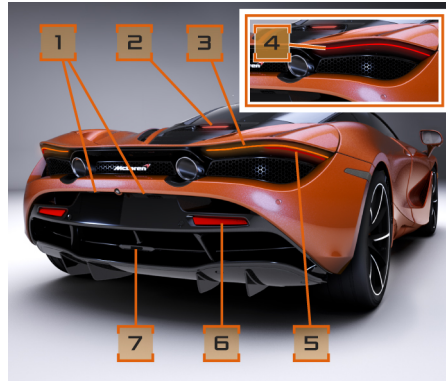

720S Coupe

1. Licence plate lamp
2. Central high mounted stop lamp
3. Direction indicator
4. Tail lamp
5. Stop lamp
6. Reflector
7. Reverse lamp and rear fog lamp

i NOTE: An additional central high mounted stop lamp is located on the underside of the Airbrake, which is visible when the Airbrake is deployed in the downforce or rapid braking position.

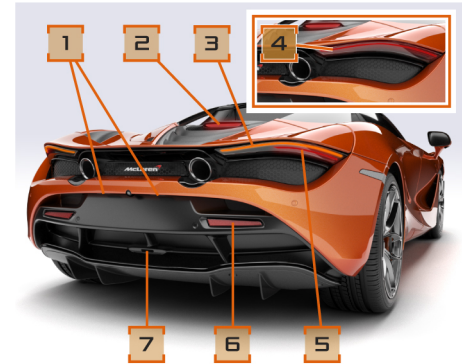

720S Spider

1. Licence plate lamp
2. Central high mounted stop lamp
3. Direction indicator
4. Tail lamp
5. Stop lamp

Before You Drive Lighting

6. Reflector
7. Reverse lamp and rear fog lamp

i NOTE: An additional central high mounted stop lamp is located on the underside of the Airbrake, which is visible when the Airbrake is deployed in the downforce or rapid braking position.

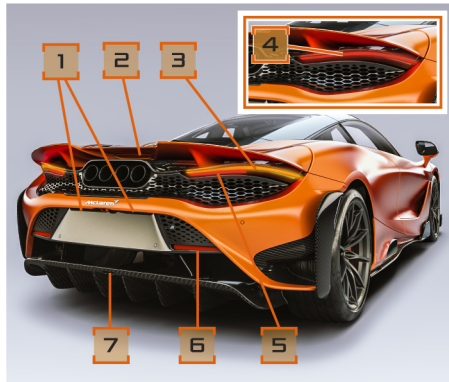

765LT Coupe

1. Licence plate lamp
2. Central high mounted stop lamp
3. Direction indicator

4. Tail lamp
5. Stop lamp
6. Reflector
7. Reverse lamp and rear fog lamp

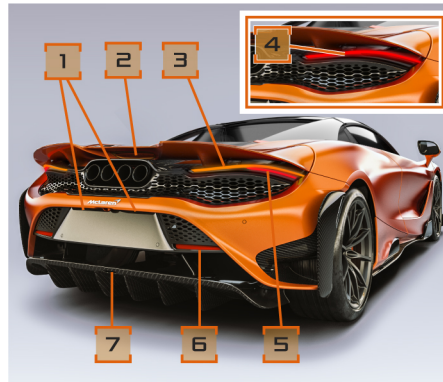

765LT Spider

1. Licence plate lamp
2. Central high mounted stop lamp
3. Direction indicator
4. Tail lamp
5. Stop lamp
6. Reflector

7. Reverse lamp and rear fog lamp

Before You Drive

Lighting

Light switch

⚠ WARNING: The lights do not switch on automatically in foggy conditions. Automatic light control is only an aid, you are responsible for the vehicle's lighting at all times.

The light switch is located between the steering wheel and the driver's door and has the following positions.

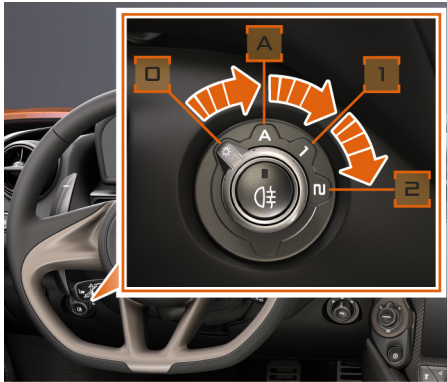

At position (0), the lights are off with the exception of daytime running lamps and tail lamps.

Rotate the control to position (A) for automatic light control.

Rotate the control to position (1) for sidelamps or position (2) for headlamps. The sidelamp warning light illuminates on the Folding Driver Display.

Automatic light control

The sidelamps and dipped beam headlamps are switched on automatically when ambient light falls below a predetermined level.

To switch on automatic light control, turn the light switch to position (A).

- i** NOTE: If the vehicle detects rain whilst the light switch is set to position (A) the dipped beam headlamps will switch on automatically, regardless of current external light levels.
- i** NOTE: With the light switch in position (A) and the rear fog lamp switched on, the dipped beam headlamps will also switch on irrespective of ambient light conditions. When the rear fog lamp is switched off, the dipped beam headlamps will also switch off.

Sidelamps

The sidelamps and the daytime running lamps are a combined series of light-emitting diodes located below the headlamp. The sidelamps operate at a lower intensity than the daytime running lamps, see Daytime running lamps, page 1.52.

The sidelamps, tail lamps and licence plate lamps illuminate when the light switch is turned to position (1).

 The sidelamp notification light on the Folding Driver Display illuminates.

- i** NOTE: The dipped beam headlamps will also switch on automatically if ambient light falls below a predetermined level.

Dipped beam headlamps

To switch on the headlamps, turn the light switch to (2).

 The dipped beam notification light on the Folding Driver Display illuminates.

- i** NOTE: On your McLaren, the same headlamp dipped beam setting applies for driving on either the left-hand or right-hand side of the road.

Before You Drive Lighting

Main beam headlamps



To switch to main beam, push the stalk away from you.

 The main beam headlamp notification light illuminates on the Folding Driver Display.

Pull the stalk towards you, to revert to dipped beam.

Headlamp flash

Pull the stalk fully towards you.

The main beam headlamps operate for as long as the stalk is held.



The main beam headlamp notification light illuminates on the Folding Driver Display.

Headlamps

Static Adaptive Headlamps



With the headlamps on, the Static Adaptive Headlamps adjust the beams when cornering, providing improved illumination in the direction of travel.

Motorway Function lighting

The Motorway Function lighting improves the headlamp illumination range when the vehicle speed exceeds a predetermined threshold.

Before You Drive Lighting

Daytime running lamps

Your McLaren is fitted with daytime running lamps which, along with the tail lamps, illuminate automatically when the ignition is switched on even if all lights are switched off. The sidelamps and the daytime running lamps are a combined series of light-emitting diodes located below the headlamp. The daytime running lamps operate at a higher intensity than the sidelamps.

Rear fog lamp

 **WARNING: The lights do not switch on automatically in foggy conditions.**

 **NOTE:** The rear fog lamp only operates when the light switch is in position (A) or (2).



Press the rear fog lamp button in the centre of the light switch.

 The rear fog lamp notification light on the Folding Driver Display and the light in the switch both illuminate.

 **NOTE:** With the light switch in position (A) and the rear fog lamp switched on, the dipped beam headlamps will also switch on irrespective of ambient light conditions. When the rear fog lamp is switched off, the dipped beam headlamps will also switch off dependent on ambient light conditions.

Before You Drive Lighting

Direction indicators

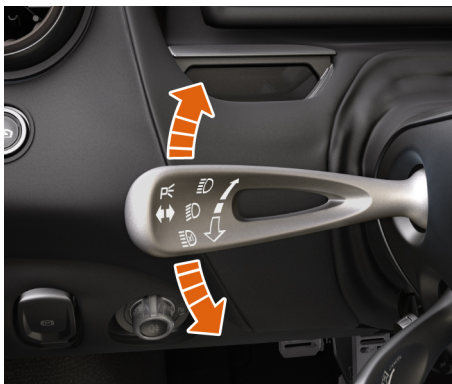

Push the direction indicator/main beam stalk downwards (1) to switch on the left-hand direction indicator.

Push the direction indicator/main beam stalk upwards (2) to switch on the right-hand direction indicator.



The corresponding notification light on the Folding Driver Display will flash.

The stalk returns to its rest position as the steering wheel returns to its central position.

Direction indicators - lane change

Move the direction indicator/main beam stalk until resistance is felt when changing lanes on a motorway. The appropriate direction indicator flashes three times.

For further information about the lighting see Light switch, page 1.50.

Hazard warning lamps

The hazard warning lamps operate even if the ignition is switched off. As a safety feature, they switch on automatically when an air bag is deployed.

Operating the hazard warning lamps



1. Press the hazard warning lamps button.
2. All the direction indicator lamps and both direction indicator warning lights on the Folding Driver Display flash.
3. Press the hazard warning lamps button again to switch off.

Before You Drive Lighting

i NOTE: If the hazard warning lamps have been switched on automatically, press the hazard warning lamps button once to switch them off.

Panic alarm

The panic alarm function is designed to attract attention by sounding the horn and flashing the direction indicator lamps repeatedly.

The panic alarm can be switched on by pressing the hazard warning lamps button for a period of 3 seconds or more.

The horn will cease after the panic alarm has been active for 60 seconds, but the direction indicator lamps will continue to flash. The horn can be re-initiated by pressing the hazard warning lamps button for a period of 3 seconds or more.

To switch the panic alarm off, press the hazard warning lamps button briefly.

Parking lights

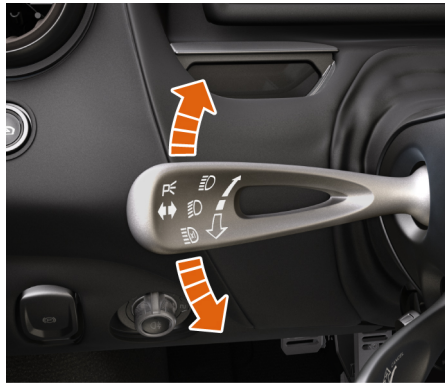

i NOTE: The parking lights can only be activated when the ignition is switched off.

1. To activate the parking lights, press the direction indicator/main beam stalk down for the left-hand side or push up for the right-hand side until resistance is felt. The selected parking lights will illuminate once the vehicle has been locked.

2. To deactivate the parking lights, press the direction indicator/main beam stalk down for the left-hand side or push up for the right-hand side until resistance is felt. The selected parking lights will then be deactivated.

i NOTE: To activate the parking lights on both sides, press the direction indicator/main beam stalk down then up. To deactivate, press the direction indicator/main beam stalk down then up again.

Before You Drive Washers and Wipers

Windscreen wipers

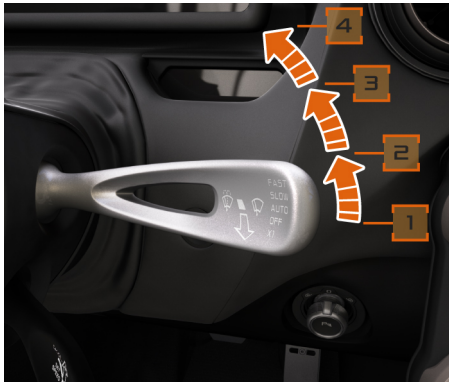

1. Windscreen wipers off
2. Automatic wipe
3. Slow wipe
4. Fast wipe

i NOTE: Switch off the windscreen wipers in dry weather, dirt can cause inadvertent wiper sweeps which could damage the wiper blades or windscreen.

Operating the windscreen wipers

1. Ensure the ignition is switched on.
2. Move the wiper stalk to the required position.

i NOTE: If the windscreen wipers are switched on and the vehicle comes to a halt, the windscreen wipers automatically switch to intermittent wipe, until the vehicle moves away.

Automatic wipe

A rain sensor, located on the windscreen behind the interior mirror, measures the quantity of water on the windscreen and operates the wipers at the most appropriate speed.

To select, move the windscreen wiper stalk to the automatic wipe position (2).

The wipers will wipe once. The wipe frequency then depends on how wet the windscreen is.

Only select the automatic wipe position in damp weather conditions or when it is raining.

To adjust the sensitivity of the rain sensor, see Wiper sensitivity, page 4.21.

Slow wipe

Move the wiper stalk to position (3), to operate the wipers at slow speed.

Return the stalk to position (1) to switch off.

Fast wipe

Move the wiper stalk to position (4), to operate the wipers at fast speed.

Return the stalk to position (1) to switch off.

Single wipe



Before You Drive

Washers and Wipers

1. For a slow single wipe, briefly push the wiper stalk down and release. The wipers will operate once at slow speed, without washers.
2. For a fast single wipe, push and hold the wiper stalk down. The windscreen wipers will perform a continuous fast wipe until the stalk is released.

Windscreen wash/wipe



Pull the wiper stalk towards you.

The windscreen washers and wipers will initially operate at a slow speed while the stalk is held. If the stalk is held for more than 2 seconds, the wiper will operate at high speed.

When the stalk is released, the wipers will complete their cycle and return to the parked position. After a period of time the wipers will operate once more to wipe any remaining washer fluid from the windscreen.

i NOTE: The position of the washer jets are set during vehicle manufacture and should not need adjusting. If a problem occurs, consult your McLaren retailer.

Wiper park positions

In addition to the normal park position, there are two alternative positions.

Ensure the vehicle is in Locked, Sleep or Awake mode.

Pull the wiper control stalk towards you, the wipers will move through the following park positions each time the stalk is pulled:

Winter park

The wipers are parked vertically to reduce the risk of damage to the wiper arms during periods of heavy snowfall and provide access for easier cleaning of accumulated snow.

Service park

The wipers are parked diagonally to provide access for replacing the wiper blades, see Replacing the wiper blades, page 6.33.

Normal park

The wipers are parked horizontally along the lower edge of the windscreen.

Before You Drive

Vehicle Lift

Vehicle lift

- i** NOTE: If the vehicle lift icon on the Folding Driver Display is amber, or a vehicle lift fault message appears on the Folding Driver Display, the system is not available. Do not drive the vehicle at high speed and contact your McLaren Retailer as soon as possible.

The vehicle lift system offers the following options:

- Vehicle lift - Raise, page 1.58
- Vehicle lift - Lower, page 1.58

Vehicle lift gives you the option to raise or lower the vehicle dependent on the current ride height.

Vehicle ride height can only be raised when travelling at speeds below 31 mph (50 km/h). The vehicle will automatically lower at speeds above 37 mph (60 km/h).

- i** NOTE: The suspension can be left fully raised for extended periods, but it may relax to a lower level over time.

If the vehicle is left in a raised position for a long period, a system reset may occur when the engine is next started to return the vehicle to normal ride height.

If vehicle lift is used when in motion, slight adjustments to the steering feel may be experienced, this is normal and does not affect the operation of the vehicle.

- i** NOTE: Vehicle handling modes are inhibited when vehicle lift is lowering or raising.
- i** NOTE: Vehicle lift will be unavailable if launch mode is active.
- i** NOTE: Vehicle lift will be unavailable if Race mode is active.
- i** NOTE: Vehicle lift is only available when the engine is running.
- i** NOTE: If vehicle lift is requested while the engine has been stopped by the Eco Start-Stop System, the engine will be automatically restarted.

Vehicle lift operation



Vehicle lift is activated by pressing the button on the control stalk on the right of the steering column, whenever the engine is running and the doors are closed.

A confirmation tone will be heard when vehicle lift is activated.

- i** NOTE: Vehicle lift is only available when the engine is running.
- i** NOTE: If vehicle lift is requested while the engine has been stopped by the Eco Start-Stop System, the engine will be automatically restarted.

Before You Drive Vehicle Lift

- i** NOTE: Vehicle handling modes are inhibited when vehicle lift is lowering or raising.
- i** NOTE: Vehicle lift will be unavailable if launch mode is active.

Vehicle lift - Raise

⚠ WARNING: On no occasion should vehicle lift be used as a jacking system. Using vehicle lift to access below the vehicle may result in serious injury.

- i** NOTE: When the vehicle is at normal ride height, you will only have the option to raise the vehicle.
- i** NOTE: Vehicle lift will be delayed if the vehicle experiences any excessive steering wheel input.
- i** NOTE: Always check the vehicle lift icon on the display before driving your vehicle.



Before vehicle lift can be activated, the engine must be running. To raise the vehicle from normal ride height, press the button on the control stalk on the right of the steering column.



The change in vehicle ride height is confirmed by an ascending audible tone. 'Vehicle raising' appears on the Folding Driver Display and the vehicle lift icon will flash.

If the engine is stopped while the vehicle is raising, the system will stop and continue to raise only when the engine is restarted.

To change from raise to lower, press the button on the control stalk on the right of the steering column again. The vehicle will start to lower, and the information displayed on the Folding Driver Display will confirm the change.

When the vehicle is fully raised, an audible confirmation tone is heard. 'Ride height raised' appears on the Folding Driver Display and the vehicle lift icon is illuminated while the vehicle remains raised.

Vehicle lift - Lower

- i** NOTE: To lower the vehicle while stationary, the engine must be running and the driver's door must be fully closed.
- i** NOTE: When the vehicle is raised, you will only have the option to lower the vehicle.
- i** NOTE: Do not drive at high speed whilst the vehicle is lowering. If the vehicle begins to auto lower, a descending audible tone is heard, and the vehicle lift menu will be displayed on the Folding Driver Display allowing you control of the system.

Before You Drive Vehicle Lift

i NOTE: Always check the vehicle lift icon on the Folding Driver Display before driving your vehicle.



To lower the vehicle from a raised ride height position, press the button on the control stalk on the right of the steering column.



The change in vehicle ride height is confirmed by a descending audible tone. 'Vehicle lowering' appears on the Folding Driver Display and the screen vehicle lift icon will flash.

To change from lower to raise, press the button on the control stalk on the right of the steering column again. The vehicle will start to raise, and the information displayed on the Folding Driver Display will confirm the change.

When the vehicle is lowered, an audible confirmation tone is heard. 'Ride height normal' appears on the Folding Driver Display and the vehicle lift icon extinguishes.

McLaren 

Driving Controls

Starting and Driving.....2.02

Vehicle electrical status.....	2.02
Switching on the ignition.....	2.03
Instruments and warning lights.....	2.03
Seamless shift gearbox gear positions.....	2.06
Parking brake.....	2.06
Brake pedal.....	2.08
Starting/stopping the engine.....	2.08
Driving.....	2.10
Exhaust temperature monitoring.....	2.12
Parking sensors.....	2.12
Rear view camera (RVC).....	2.14
360 Park Assist.....	2.15

Seamless Shift Gearbox.....2.16

Overview.....	2.16
Gear positions.....	2.16
Accelerator pedal position.....	2.17
Manual/automatic mode.....	2.18

Handling and Powertrain Controls.....2.21

Active dynamics control.....	2.21
Active button.....	2.21
Handling control.....	2.22
Powertrain control.....	2.24
Launch control.....	2.26

Driving Safety Systems.....2.29

General.....	2.29
Anti-lock braking system (ABS).....	2.29

Brake assist system.....	2.30
Brake disc wiping.....	2.30
Hill hold control.....	2.31
Brake-steer.....	2.31
Electronic brake pre-fill.....	2.31
Electronic stability control (ESC).....	2.32
Airbrake.....	2.34
Tyre pressure monitoring system (TPMS).....	2.38

Cruise Control.....2.41

Overview.....	2.41
Using cruise control.....	2.41
Cancelling cruise control.....	2.42
Increasing cruise control speed.....	2.43
Reducing cruise control speed.....	2.43
Resuming a stored speed.....	2.44

Active Speed Limiter (ASL).....2.45

Setting an upper speed limit.....	2.45
Cancelling Active Speed Limiter (ASL).....	2.46

Running In.....2.47

Running in.....	2.47
Normal/road use.....	2.47
Track use.....	2.48

Refuelling.....2.49

Filling with fuel.....	2.49
Recommended fuel.....	2.50

Winter Driving.....2.52

Winter driving.....	2.52
---------------------	------

Driving Controls

Starting and Driving

Vehicle electrical status

The vehicle will implement one of the following statuses according to the criteria detailed.

i NOTE: The engine can be started from any of the following states, except Locked. If the vehicle is in Sleep mode, the START/STOP button will need to be pressed for more than 2 seconds.

i NOTE: If the vehicle detects the battery charge is getting too low, it will adopt the Awake mode to conserve energy. Ignition will be prohibited, but Crank will still be available. This is to allow the engine to be started so that battery recharging can commence.

Locked

Vehicle is locked in low power mode.

Sleep

Vehicle is unlocked in low power mode.

Awake

Door is opened or START/STOP button pressed, when the vehicle is in Sleep mode.

Time, odometer reading, battery status and fuel gauge are available on the Folding Driver Display.

If there is no further activity after 60 seconds, the vehicle will return to the Sleep mode.

Ignition

START/STOP button is pressed, when the vehicle is in Awake mode.

Windows and heater/air conditioning controls operate. Folding Driver Display menus and McLaren Infotainment System (MIS) are available.

i NOTE: There is no timeout with ignition on. Be aware that the battery could become discharged.

Crank

See Starting/stopping the engine, page 2.08.

Power saving mode

Under very rare circumstances, the vehicle may not be able to supply enough voltage and will activate power saving mode.

⚠ WARNING: When power saving mode is active, the climate control and steering will operate with reduced effect.

i NOTE: When power saving mode is active, the message 'Battery management active - See owner's manual' appears on the Folding Driver Display.

Parking days



When the vehicle is in Awake mode the number of "days parking" remaining will be displayed on the Folding Driver Display. This indicates how many days the vehicle can be parked, without running the engine or connecting a battery charger, before the battery will become discharged.

Driving Controls

Starting and Driving

Switching on the ignition



1. Ensure that the key fob is inside the vehicle.
2. To switch on the ignition without starting the engine, press the START/STOP button, without depressing the brake pedal.

i NOTE: If the vehicle is in Awake mode, press the START/STOP button twice with the brake pedal released.





3. The ignition will switch on, the oil temperature, water temperature and fuel gauges will operate and several of the warning lights will illuminate as a self-test. The Folding Driver Display will fully illuminate.

Instruments and warning lights

Warning lights can be divided into different categories, according to the colour that they illuminate.







- RED or AMBER warning light - indicates that a fault has been detected. A fault indicated by a RED light is more important than one displayed in AMBER.
- BLUE or GREEN notification light - indicates that a system or feature is switched on and operating.





Warning lights

	Tyre pressure monitoring system (TPMS), page 2.38
	Seat belt warning light, page 1.38
	Rear fog lamp, page 1.52
	Supplementary restraint system (SRS) warning light, page 1.42





Driving Controls

Starting and Driving

	Electronic stability control (ESC), page 2.32
	Engine warning light, page 2.11
	Anti-lock braking system (ABS) status light, page 2.30
	Brake warning light, page 2.08 Parking brake status, page 2.06
	Low oil pressure warning light. If this illuminates, stop the vehicle as soon as safety permits and contact your McLaren retailer immediately.
	Engine coolant hot warning light. If this illuminates, stop the vehicle as soon as safety permits and contact your McLaren retailer immediately.
	No charge warning light. If this illuminates, stop the vehicle as soon as safety permits and contact your McLaren retailer immediately.

	Electronic stability control system failure warning light. If this illuminates, adapt your driving style while the fault exists. Contact your McLaren retailer.
	Low fuel level warning light. If this illuminates, refuel your vehicle at the soonest opportunity. See Filling with fuel, page 2.49
	Generic failure warning light. A message will be shown on the Folding Driver Display when this is illuminated, stop the vehicle as soon as safety permits and contact your McLaren retailer immediately.
	Generic failure caution light. A message will be shown on the Folding Driver Display when this is illuminated, stop the vehicle as soon as safety permits and contact your McLaren retailer immediately.

Notification lights

	Direction indicators, page 1.53
	Main beam headlamps, page 1.51
	Dipped beam headlamps, page 1.50
	Sidelamps, page 1.50
	Direction indicators, page 1.53

Driving Controls

Starting and Driving

Folding Driver Display overview



1. Tachometer, page 3.02
2. Speedometer, page 3.03

Folding Driver Display - left-hand side



The Folding Driver Display provides important information to the driver and will vary depending on the mode and vehicle settings selected.



Use the control stalk to navigate through the menus.

Driving Controls

Starting and Driving

Folding Driver Display - right-hand side

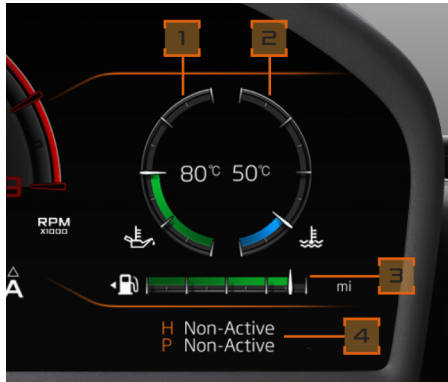

1. Oil temperature, page 3.20
2. Water temperature, page 3.20
3. Fuel level and range, page 3.21
4. Handling control, page 2.22
Powertrain control, page 2.24

Seamless shift gearbox gear positions

The gearbox operates in either automatic or manual mode. Automatic mode is selected unless the driver chooses manual mode, see Gear positions, page 2.16 and Manual/automatic mode, page 2.18. If manual mode is active, gear changes are made using the gearshift paddles, see Gearshift paddles, page 2.19.

Parking brake

i NOTE: When parking on steep downhill slopes, turn the front wheels towards the kerb. When parking on steep uphill slopes, turn the front wheels away from the kerb.

Parking brake status

! If the parking brake applied status light is flashing, the parking brake has failed to engage/disengage. To resolve, engage/disengage the parking brake again. See Parking brake operation, page 2.07.

Driving Controls

Starting and Driving

Parking brake operation



To engage the parking brake, pull the switch outwards, the red parking brake applied status light on the Folding Driver Display illuminates.

- i** NOTE: The parking brake on your vehicle is electronic and only a light application of the switch is required to engage or disengage the parking brake.



To disengage the parking brake, keep the brake pedal depressed and push the parking brake switch inwards, the red parking brake applied status light on the Folding Driver Display extinguishes.

! **WARNING: If the parking brake is manually released, the vehicle may start to move.**

- i** NOTE: If the parking brake is not manually released, it will automatically release as the vehicle is driven off forward, or in reverse as long as the following conditions are met:
 - Driver's door is closed

- Driver's seat belt is buckled
- i** NOTE: If the parking brake is not manually applied it will automatically apply when the engine is switched off.
- i** NOTE: It is only possible to disengage the parking brake with the ignition on. The parking brake can be applied in all ignition states, including vehicle asleep.
- i** NOTE: In the event of total footbrake failure, the parking brake can be applied when the vehicle is moving to slow the vehicle.

Driving Controls

Starting and Driving

Brake pedal

- WARNING:** Do not keep any objects in the driver's footwell. Ensure that floor mats or carpets are properly secured and do not obstruct the pedals.
If objects become trapped between the pedals, you may not be able to brake or accelerate, and this could lead to an accident.
- WARNING:** The braking system is servo assisted when the engine is running. The brakes will still function with the engine off, but more pressure will be required to operate them.
- WARNING:** Do not rest your foot on the brake pedal while travelling as this may overheat the brakes, reduce their efficiency and cause excessive wear.
- WARNING:** If the brake warning light illuminates while the vehicle is in motion, stop the vehicle as soon as safety permits and contact your McLaren retailer immediately.

Brake discs and pads

- WARNING:** New brake pads require a period of bedding in. For the first 625 miles (1,000 km), avoid situations where heavy braking is required.

Brake disc and pad wear depends on the driving style and driving conditions.

Brake warning light

- !** The brake warning light will illuminate when the ignition is switched on as a system test. If the brake warning light illuminates at any other time, a fault is indicated. Stop the vehicle as soon as safety permits and contact your McLaren retailer immediately.

Starting/stopping the engine

- WARNING:** Never run the engine when the vehicle is in an enclosed space. Exhaust fumes contain poisonous carbon monoxide. Breathing exhaust fumes could lead to unconsciousness and death.
- NOTE:** Do not depress the accelerator pedal when starting the engine.

Starting the engine

1. Ensure that the key fob is in the vehicle.



Driving Controls

Starting and Driving

2. Depress the brake pedal, press and release the **START/STOP** button and the engine will start.
3. If the **START/STOP** button is pressed again while the engine is cranking, cranking is stopped.

Stopping the engine

1. Depress the brake pedal.
2. Select neutral.



3. Press the **START/STOP** button. The engine stops, the vehicle enters Awake mode, see Vehicle electrical status, page 2.02. The immobiliser is activated.

i NOTE: The parking brake will apply automatically when the engine is stopped. Automatic application can be overridden by holding the parking brake switch in the off position whilst opening the driver's door.

Eco Start-Stop system

This system automatically stops the engine when conditions allow in order to reduce fuel consumption and exhaust gas emissions and restarts it again when required.

The following conditions must be met for the system to automatically stop the engine:

- Driver is detected as present
- Driving speed exceeded 6 mph (10 km/h) since previous stop
- Engine at normal operating temperature
- Vehicle battery fully charged
- Air conditioning demand not too high
- Comfort Powertrain mode active

System operation



At very low speeds a status icon will be shown on the Folding Driver Display.

The icon will illuminate amber if conditions have not been met and the system is not available.

If all conditions have been met and the system is available, the icon will illuminate green.

The system will automatically stop the engine when the brake pedal is depressed and the vehicle slows to a complete stop.

The message 'ENGINE STOPPED' will be shown on the Folding Driver Display.

Driving Controls

Starting and Driving

The engine will automatically restart when the brake pedal is released or any conditions that require the engine to restart are detected.

i NOTE: If the parking brake is engaged while the engine is stopped, the engine will not restart when the brake pedal is released.

Depress the brake pedal, disengage the parking brake and then release the brake pedal in order to initiate the automatic restart.

i NOTE: The engine may automatically re-start before the brake pedal is released in order to maintain electrical, air conditioning or other vehicle demand.

Deactivating



Press the Eco Start-Stop system OFF button to deactivate the system. The light in the button will illuminate and the status light on the Folding Driver Display will be extinguished.

Press the button again to activate the system.

i NOTE: If the Eco Start-Stop system OFF button is pressed when the engine has been automatically stopped, the engine will re-start.

i NOTE: The system is active by default when the ignition is switched on, even if it has been previously deactivated.

Driving

Driving away

⚠ **WARNING:** Never turn the engine off while driving, there will be no assistance for the steering or the foot brake. You will need more effort to steer and brake and could lose control of the vehicle and cause an accident.

i NOTE: Do not drive at high engine speeds until the engine has reached normal operating temperature.

i NOTE: The doors will lock when the vehicle reaches a speed of approximately 9 mph (15 km/h). Auto lock can be set on the Central Display, see Automatic door locking, page 4.19.

i NOTE: During extensive parking manoeuvres the steering assistance might feel slightly stiffer. This is normal and designed to protect the steering system from overheating.

Driving Controls

Starting and Driving

i NOTE: When starting from cold, engine idle speed may be increased and gear changes may occur at higher engine speeds. The catalytic converter will reach its operating temperature quicker and reduce engine emissions.

1. With the engine running, press and hold the brake pedal.
2. Select drive or reverse gear, or initiate an upshift by operating the gearshift paddles. For more information, see Gearshift paddles, page 2.19 and Gear positions, page 2.16.
3. Keep the brake pedal depressed and release the parking brake switch. The red status light on the Folding Driver Display will be extinguished.

! **WARNING: If the parking brake is manually released, the vehicle may start to move.**

i NOTE: If the parking brake is not manually released, it will automatically release as the vehicle is driven off forward, or in reverse as long as the following conditions are met:

- All doors are closed

- Driver's seat belt is buckled

4. Carefully depress the accelerator pedal.

Engine warning light



This engine warning light illuminates when the ignition is on and extinguishes as soon as the engine is started, provided no faults exist.

If the light illuminates while driving, an engine management fault has been detected and reduced engine performance may be experienced. Stop the vehicle as soon as safety permits and contact your McLaren retailer immediately.

Limhome mode

Limhome mode activates automatically when vehicle systems detect a fault which may cause further damage unless vehicle or system performance is restricted. Care should be taken while driving in this mode. Contact your McLaren retailer immediately.

Economical driving

Improved fuel economy can be achieved by following this advice:

- Accelerate smoothly and gently from a standing start.
- When in manual mode, avoid high engine rpm by changing to a higher gear as soon as possible.



The gear shift indicator (GSI) will illuminate when an upshift would maintain optimum economy.

i NOTE: Not available in all markets, consult your McLaren retailer.

- Avoid labouring or over-revving the engine.
- Switch off the air conditioning when it is not needed.
- Avoid journeys where frequent stop/start driving is involved.
- Ensure that your driving style suits the prevailing road and traffic conditions; allow time for smooth, progressive acceleration and braking.

Driving Controls

Starting and Driving

Exhaust temperature monitoring

The vehicle continuously monitors exhaust temperatures to protect the catalytic converters from damage caused by overheating.

If excessive exhaust temperatures are measured, a warning will be displayed on the Folding Driver Display.

The vehicle speed should be reduced as soon as this message is observed. Refrain from manoeuvres involving high engine speed and high engine load (full throttle) to allow the exhaust to cool. The message will remain until the temperature has reduced.

If the exhaust temperature remains at an excessive level, a second warning is displayed and limhome mode is activated. The engine performance will remain limited until the vehicle is restarted.

i NOTE: Catalytic converter over temperature warnings are not likely to be observed during normal driving and are the result of extreme operating conditions. For example, high exhaust temperatures can be caused by extended track driving, maintaining high engine speed for long durations, and sudden and repeated changes in throttle demand.

i NOTE: High exhaust temperatures can cause damage to catalytic converters and should be avoided by practicing careful driving.

If the warnings persist, contact your McLaren retailer.

Parking sensors



The parking sensors alert the driver to any obstructions while manoeuvring at low speeds. The system comprises four ultrasonic sensors in the front bumper, four ultrasonic sensors in the rear bumper and two sounders. Each sounder has a different pitch to indicate whether the obstruction is at the front or the rear of the vehicle.

Driving Controls

Starting and Driving

The front parking sensors are automatically switched on when the engine is running and drive is selected. The rear parking sensors are switched on when reverse gear is selected. The light around the parking sensors button will illuminate amber to indicate that parking sensors are active.

Front parking sensors can be activated when the vehicle is in neutral and the system is manually turned on.

The centre sensors on the front bumper have a range of approximately 1 m (3 ft). The centre sensors in the rear bumper have a range of approximately 1.5 m (5 ft).

An intermittent tone is heard when an obstruction is within range. As the vehicle moves closer to an obstruction, the frequency of the tone increases. When the distance between the sensors and the obstruction is less than approximately 40 cm (1 ft 6 in), the tone becomes continuous.

 **WARNING: The parking sensors may not detect moving objects such as children and animals until they are dangerously close. Always manoeuvre with caution and always use your mirrors, turn your head and look behind you.**

 **NOTE: The parking sensors are for guidance only and are not intended to replace the driver's visual checks for obstructions when manoeuvring. The parking sensors may not detect some obstructions, such as narrow posts or small obstructions close to the ground such as kerbs.**

The rear parking sensors are automatically switched off when reverse gear is de-selected. The front parking sensors are automatically switched off when the vehicle speed exceeds 16 mph (26 km/h) and drive is selected. If the parking sensors have been manually activated, by pressing the centre of the button, the front parking sensors will become active again when the vehicle speed reduces to 12 mph (20 km/h).

The parking sensors can be switched off manually by pressing and holding the centre of the button, to remove the parking sensor proximity view from the Central Infotainment Touchscreen press centre of the button when in drive or neutral. The parking sensors cannot be manually switched off if reverse gear is selected. When manually switched off, the light around the button will be extinguished.

When the system has been manually switched off, both the front and rear sensors will still switch on when reverse gear is selected and remain on until drive or neutral is selected again.

If a fault is detected the system will be disabled and message will appear in the Folding Driver Display, the parking sensor button light will flash. If the sensors are obscured by dirt, ice or snow, clean them. If the problem persists, contact your McLaren retailer.

Driving Controls

Starting and Driving

Rear view camera (RVC)



The rear view camera (RVC) is mounted in the centre of the rear bumper. The live video feed is displayed on the Folding Driver Display when the function is active.

- i** NOTE: If the video feed is blurred or unclear, carefully clean the lens with water and a soft cloth.
- i** NOTE: If the Folding Driver Display is in Slim Display Mode the RVC will be displayed on the Central Infotainment Touchscreen.

- i** NOTE: Slim Display Mode will not be available whilst the RVC is active.

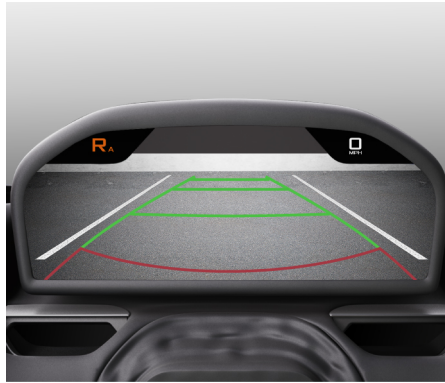

A coloured grid is overlaid onto the live video feed as a guide to the proximity of visible objects to the rear of the vehicle.

Each coloured box starts at the rear of the vehicle and extends 25 cm (10 in) beyond the widest point of the vehicle and extends back, away from the vehicle.

The red box extends back 40 cm (1 ft 6 in) from the rear of the vehicle.

The green box extends back 2 m (6 ft 7 in) from the rear of the vehicle, with an additional line at 1 m (3 ft 4 in).

- i** NOTE: The rear view camera is for guidance only and is not intended to replace the driver's visual checks for obstructions when manoeuvring. The rear view camera may not show some obstructions in certain ambient light or weather conditions.

The RVC is automatically activated when reverse gear is selected and automatically deactivated 10 seconds after a forward gear is selected or immediately if the vehicle's forward speed exceeds 6 mph (10 km/h).

The RVC can be manually activated by selecting Rear view camera on the Central Infotainment Touchscreen Home screen.

- 📺** When the RVC has been manually activated and is displayed on the Central Infotainment Touchscreen, it can be deactivated by touching the on-screen icon. The RVC will also be deactivated if the screen is touched anywhere below the status bar or any of the physical Central Infotainment Touchscreen buttons are pressed.

Driving Controls

Starting and Driving

360 Park Assist



360 Park Assist will display a live video showing a 360 degree view around the vehicle in the Central Infotainment Touchscreen.

360 Park Assist is switched on when reverse gear is selected. The light around the parking sensors button will illuminate amber to indicate that 360 Park Assist and the parking sensors are active.

The 360 Park Assist visual display can be manually activated or deactivated with a short press of the parking sensors button. A long press of the button will deactivate the system and the four front parking sensors. When deactivated, the light around the button will be extinguished.

- i** NOTE: 360 Park Assist cannot be deactivated if reverse gear is selected.
- i** NOTE: If the mirrors are folded, 360 Park Assist is not enabled and the following will be displayed on the Central Infotainment Touchscreen '360 Park Assist is not available when the side mirrors are folded'.

When the Folding Driver Display is in Slim Display Mode the 360 degree view in the Central Infotainment Touchscreen will be replaced with the rear view camera (RVC) view.

- i** NOTE: 360 Park Assist is for guidance only and is not intended to replace the driver's visual checks for obstructions when manoeuvring.

When 360 Park Assist has been manually deactivated, it will be reactivated when reverse gear is selected and remain active until drive or neutral is selected again. It can also be reactivated with a short press of the parking sensors button.

Driving Controls

Seamless Shift Gearbox

Overview

The gearbox is a 7-speed, dual clutch seamless shift gearbox that can be operated in automatic or manual mode.

Automatic mode is selected unless the driver chooses manual mode, see Manual/automatic mode, page 2.18.

In automatic mode, the gearbox automatically optimises the shift points to suit your style of driving by selecting the most appropriate gear depending on:

- Powertrain control, page 2.24.
- Accelerator pedal position, page 2.17.
- vehicle speed.
- braking effort.

i NOTE: Allow the engine and gearbox to warm up before driving at high engine speeds and high loads. Avoid prolonged spinning of the rear wheels when driving on slippery surfaces as this could damage the drivetrain.

Gear positions



Press one of the gear position buttons.

i NOTE: The letter on each button will illuminate red to identify if the vehicle is in Drive, Neutral or Reverse.

Drive

□ All seven forward gears are available. Gear changes will be automatic, unless manual mode has been selected.

When drive is selected and the brakes are released, the vehicle will begin to move slowly without any throttle use, making it useful for parking manoeuvres and for moving off in queuing traffic.

Neutral

N No gear is engaged. Releasing the brakes will allow the vehicle to move freely, e.g. for pushing or towing. For more information on use of neutral for towing, see Towing for recovery, page 6.46.

Neutral can be selected at any vehicle speed by pressing the N button. Pressing the D button or initiating a shift by operating the gearshift paddles will then select the appropriate gear for the vehicle speed.

Reverse

R In normal circumstances, select reverse gear when the vehicle is stationary. When carrying out parking manoeuvres that require rapid changes from drive to reverse and back again, it is possible to engage reverse or drive at speeds up to 6 mph (10 km/h) whilst travelling in the opposite direction.

Driving Controls

Seamless Shift Gearbox

- i** NOTE: If reverse or drive is selected at speeds above 6 mph (10 km/h), the transmission will engage neutral, as a self protection feature. When travelling at speeds below 6 mph (10 km/h), neutral can be selected by pressing the N button. When reverse is selected and the brakes are released, the vehicle will begin to move slowly without any throttle use, making it useful for parking manoeuvres.



The gear (manual mode) or the gear position (automatic mode) selected will be shown on the Folding Driver Display.

- i** NOTE: The gear position will not be displayed if there is a system communication fault. A warning message will appear on the Folding Driver Display to inform you of the fault.

Accelerator pedal position

Your style of driving influences how the seamless shift gearbox changes gear.

With light accelerator pedal use, upshifts are made at lower engine speeds. With firmer accelerator pedal use, upshifts are made at higher engine speeds.

Kickdown

Kickdown is designed to achieve immediate acceleration when in automatic mode.

Depress the accelerator pedal fully beyond the pressure point, a click will be felt through the pedal. The gearbox will downshift immediately to the lowest appropriate gear, and maximum acceleration will follow. Once the pedal pressure is released, kickdown will cease and normal gear changes will resume.

- i** NOTE: Moderate accelerator pedal pressure may also cause the gearbox to downshift, depending on vehicle speed.

Driving Controls

Seamless Shift Gearbox

Manual/automatic mode



Press the **ACTIVE** button (1) to switch on the Active Dynamics Panel.

The halo around the **ACTIVE** button will come on. When selecting the different drive modes, their respective button will become illuminated. You can deactivate your drive mode selection at any time by pressing the **ACTIVE** button again. Press the **MANUAL** button (2) to select manual mode.



The gearbox mode indicator displays **M** and the currently selected gear. All forward gear changes are made by operating the gearshift paddles, see Gearshift paddles, page 2.19.

Performance shift cue (PSC) is an indicator that will sound to indicate that an upshift is required to maintain optimum performance.

For setting options see Performance Shift Cue (PSC), page 4.19.

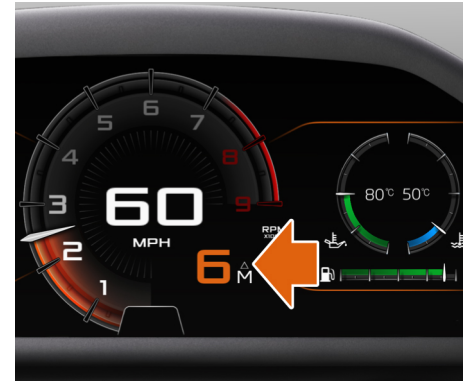

When in manual mode and driving more economically, the gear shift indicator (GSI) will illuminate when an upshift would maintain optimum economy. The GSI will not illuminate if the requested acceleration or deceleration cannot be met with a higher gear. See Economical driving, page 2.11.

i **NOTE:** Not available in all markets, consult your McLaren retailer.

Press the **MANUAL** button again to revert to automatic mode.

Driving Controls

Seamless Shift Gearbox



The gearbox mode indicator displays A. All gear changes occur automatically, but if a gearshift paddle is operated the gearbox will adopt a temporary manual mode. This mode will remain active for as long as the driver continues to make manual gear changes, each within an eight second period. The gearbox mode indicator displays A/M, see Gear position indicator, page 3.19.

i NOTE: As soon as an eight second period has elapsed without a manual gear change being made, the gearbox will revert to automatic mode.

Gearshift paddles



To upshift, pull the right-hand paddle towards you. To downshift pull the left-hand paddle towards you. The current gear position appears on the gear position display, see Gear position indicator, page 3.19.

i NOTE: The single-piece paddle and central pivot enables upshifts and downshifts to be made using either paddle.

As an alternative, upshifts can be made by pushing the left-hand paddle away from you and downshifts can be made by pushing the right-hand paddle away from you.

The gearshift paddles operate irrespective of the handling and powertrain mode selected, and there is no need to release the accelerator pedal to change gear.

⚠ WARNING: For safety, in manual mode, the vehicle will monitor engine speed and may perform an automatic gear change if necessary.

⚠ WARNING: Do not change down for additional engine braking on a slippery surface.

i NOTE: If operating the paddles in automatic mode, the gearbox will revert to automatic changes if an eight second period elapses without a gear change being made.

To immediately shift to the lowest possible gear whilst the vehicle is braking, select and hold a downshift on the paddle. The vehicle will then go down through all gears sequentially until the optimum gear is reached or you release the paddle.

Driving Controls

Seamless Shift Gearbox

When the vehicle speed is below 6 mph (10 km/h) or the vehicle is stationary with a gear selected, select a downshift and hold the paddle to select neutral.

Neutral can be selected at any vehicle speed by pressing the N button. Pressing the D button or initiating a shift by operating the gearshift paddles will then select the appropriate gear for the vehicle speed.

Pre-Cog

The gearbox will anticipate the next gear change and pre-select the required gear to ensure fast and seamless gear change.

When the vehicle is under acceleration, the gearbox will automatically pre-select the next highest gear. If a downshift is required immediately following hard acceleration, lightly pull and hold the downshift paddle to the Pre-Cog position to pre-select the next lowest gear. When ready, fully pull the paddle for an almost instantaneous downshift.

To pre-select an upshift during deceleration, lightly pull and hold the upshift paddle to the Pre-Cog position to pre-select the next highest gear. When ready, fully pull the paddle for an almost instantaneous upshift instead of the automatically pre-selected downshift.

Driving Controls

Handling and Powertrain Controls

Active dynamics control

The handling and powertrain control switches, on the Active Dynamics Panel, allow the driver to change the handling and performance characteristics of the vehicle.

The Active Dynamics Panel contains the following controls, and will only function with the engine running or the ignition switched on.

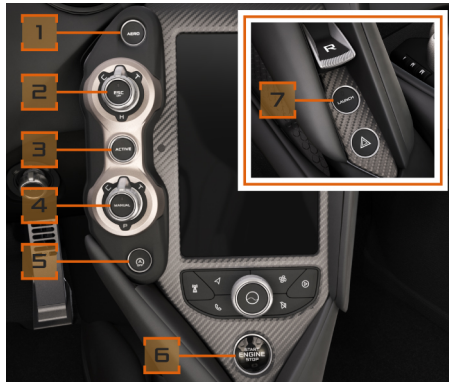

1. Airbrake - AERO button ON, page 2.35
2. Handling control, page 2.22
3. Active button, page 2.21
4. Powertrain control, page 2.24

5. Eco Start-Stop system, page 2.09
6. Engine START/STOP button, see Vehicle electrical status, page 2.02
7. Launch control, page 2.26

Active button



Pressing the ACTIVE button switches on the Active Dynamics Panel. This activates the Launch, Aero, ESC off, handling and powertrain controls. The ACTIVE button and handling and powertrain switches will illuminate.

i NOTE: When the Active Dynamics Panel is on, the current handling and powertrain modes will appear in amber on the Folding Driver Display. When the panel is off, the handling and powertrain modes will appear in white.

Driving Controls

Handling and Powertrain Controls

i NOTE: When the ignition is switched off, the controls on the Active Dynamics Panel will also switch off. The handling and powertrain control modes will be remembered but it will be necessary to press the ACTIVE button again to operate the controls when the ignition is next switched on or the vehicle will revert to automatic gear changes.

Handling control

The handling control switch affects the Proactive Chassis Control II system.

Selecting a mode



1. Press the ACTIVE button to switch on the Active Dynamics Panel.



2. Rotate the handling control to select one of the following modes.

Driving Controls

Handling and Powertrain Controls

Modes

C	Comfort	Suspension at its softest setting, offers a compliant ride while maintaining good body control through corners.
S	Sport / Non-Active	Suspension is stiffer, giving a firmer ride coupled with enhanced handling characteristics. Active aerodynamics (Airbrake) becomes available to further enhance vehicle handling.
T	Track	The suspension is at its stiffest, giving almost race car handling and ride characteristics. Active aerodynamics (Airbrake) becomes available to further enhance vehicle handling. The Electronic Stability Control warning light is permanently illuminated.

i NOTE: The information displayed on the Folding Driver Display will change dependent on the handling mode

selected. See Handling and powertrain display, page 3.19.

The mode selected will remain active, until the selection is changed, the ignition is switched off, or the Active Dynamics Panel is deactivated.

i NOTE: If all the following conditions are not met when the selection is made, the mode will not be implemented until they are met:

- No fault conditions existing
- No vehicle dynamic or stability interventions activated, e.g. electronic stability control
- Steering wheel in straight ahead position, and not being turned, if the vehicle is moving

When the Active Dynamics Panel is off, the handling display on the Folding Driver Display will show Non-Active, see Handling and powertrain display, page 3.19.

When the vehicle is in Non-Active mode, the handling characteristics will match those of Sport handling mode.

i NOTE: In Track handling mode, the electronic stability control system is still in operation. For further information, see Electronic stability control (ESC), page 2.32.

Driving Controls

Handling and Powertrain Controls

Powertrain control

Selecting a mode



1. Press the **ACTIVE** button to switch on the Active Dynamics Panel.



2. Rotate the powertrain control to select one of the following modes.

The shift strategy will vary, depending on the powertrain mode selected.

Active modes

Automatic mode		
C	Comfort	Gear changes are configured to offer the optimum economy without sacrificing the vehicle's inherent performance.
S	Sport	Gear changes will occur at a higher engine speed and with a reduced shift duration and are further enhanced with cylinder cut. See Cylinder cut, page 7.18.
T	Track	Gear changes occur instantly, according to throttle response and are further enhanced with cylinder cut. See Cylinder cut, page 7.18.

Driving Controls

Handling and Powertrain Controls

		Manual mode
C	Comfort	Gear changes are configured to offer optimum comfort and are enhanced with cylinder cut. See Cylinder cut, page 7.18.
S	Sport	Gear changes occur with a reduced shift duration and are further enhanced with ignition cut. See Ignition cut, page 7.19.
T	Track	Gear change strategy is at its sharpest. Changes occur instantly and are further enhanced with inertia push. See Inertia push, page 7.19.

i NOTE: The information displayed on the Folding Driver Display will change dependent on the powertrain mode selected. See Handling and powertrain display, page 3.19.

i NOTE: The use of Track mode on the public road is not recommended. Track mode is strictly intended for high performance track/off road use only.

The mode selected will remain active, until the selection is changed, the ignition is switched off, or the Active Dynamics Panel is deactivated.

When the Active Dynamics Panel is off, the powertrain display on the Folding Driver Display will show Non-Active, see Handling and powertrain display, page 3.19.

Non-Active mode

In both automatic and manual modes, gear changes occur with a reduced shift duration and are further enhanced with inertia push. See Inertia push, page 7.19.

Economy mode



When the vehicle is operating in any powertrain mode with automatic gear shifts selected, the transmission adapts to an economical shift strategy during periods of gentle driving. This is determined by the vehicle speed, acceleration, braking and road gradient.

Depending on the current active shift strategy, the word 'Non-Active', 'Comfort', 'Sport' or 'Track' changes colour to green when economy mode is active. For information on other ways to save fuel, see Economical driving, page 2.11.

Driving Controls

Handling and Powertrain Controls

 NOTE: When the Active Dynamics Panel is on, the current handling and powertrain modes will appear in amber on the Folding Driver Display. When the panel is off, the handling and powertrain mode 'Non-Active' will appear in white.

Launch control

Launch control is designed to offer the maximum acceleration from a standing start.

 **WARNING: Do not initiate launch control unless on a track. Before initiating launch control, ensure that all doors, luggage compartment and service cover are closed, and the prevailing conditions are suitable for performing maximum acceleration manoeuvres.**

 NOTE: Launch control can be operated in either automatic or manual modes and any handling or powertrain mode, but only when the Active Dynamics Panel is activated.

 NOTE: The launch sequence can be aborted at any point by carrying out any of the following actions:

- Applying the parking brake
- Pressing the ACTIVE button to switch off the vehicle dynamics panel
- Pressing the LAUNCH button to switch off launch control

 NOTE: If there is a fault or the launch procedure has not been followed correctly, a warning message 'Launch Mode unavailable - See owner's manual' will be shown on the Folding Driver Display. Repeat the launch procedure, ensuring that it is followed correctly. If the warning message remains, contact your McLaren retailer.

 NOTE: Launch mode is only available if the following conditions are met:

- Both doors are closed
- Vehicle ride height normal and vehicle lift function inactive
- Atmospheric altitude has no detrimental effect with respect to engine performance
- Engine coolant at normal operating temperature

Launch control process

1. Ensure the steering wheel is in a straight ahead position.
2. Depress the brake pedal firmly with your left foot and select first gear.

Driving Controls

Handling and Powertrain Controls



3. Press the ACTIVE button to switch on the Active Dynamics Panel.



4. Press the LAUNCH button.

i NOTE: L will flash in the gearbox mode indicator, see Manual/automatic mode, page 2.18 and 'Launch Mode active - Awaiting full throttle' will be shown on the Folding Driver Display.

5. With your left foot remaining on the brake pedal, press and hold the accelerator pedal down fully with your right foot, the engine speed will increase to 3,200 rpm.

i NOTE: To abort launch control release the brake pedal before pressing the accelerator pedal or wait for approximately 100 seconds until launch control is deactivated. The message 'Launch Mode aborted - See owner's manual' will be shown on the Folding Driver Display.

i NOTE: The message 'Launch Mode active - Boost building' will be shown on the Folding Driver Display. Once sufficient boost has been achieved, the message 'Launch Mode active - Boost ready' will be shown on the Folding Driver Display.

6. Release the brake pedal with your left foot and the launch control system will perform a launch start to give maximum acceleration.

i NOTE: To abort launch control release the accelerator pedal or wait for approximately 5-10 seconds until launch control is deactivated. If the launch is aborted, release the accelerator pedal and then press again to drive away. The message 'Launch Mode aborted - See owner's manual' will be shown on the Folding Driver Display.

Driving Controls

Handling and Powertrain Controls

7. Launch control will operate if the procedure has been followed correctly until aborted.



NOTE: Whilst in launch control, the vehicle will carry out automatic gear shifts, and optimise traction. It will continue to do so until launch control is aborted. To abort launch control, release the accelerator pedal, apply the brake, or operate one of the gearshift paddles.

Driving Controls

Driving Safety Systems

General

This section contains information about the following safety systems:

- Anti-lock braking system (ABS)
- Brake assist system
- Brake disc wiping
- Hill hold
- Brake-steer
- Electronic brake pre-fill
- Electronic stability control (ESC)
- Airbrake

 **WARNING: The risk of an accident increases when driving quickly, especially when cornering, on wet and icy roads. Always maintain a safe distance to the vehicle in front. Always adapt your driving style to suit the road and weather conditions and maintain a sufficient distance from other road users and objects on the road.**

 **NOTE:** In winter conditions, the maximum effect of the anti-lock braking system, brake assist system and electronic stability control can only be achieved if you use winter tyres, with snow socks where they are necessary.

Anti-lock braking system (ABS)

The anti-lock braking system prevents the wheels from locking when you brake. This allows the vehicle to be steered during braking manoeuvres.

The anti-lock braking system works from a speed of approximately 5 mph (8 km/h) upwards, regardless of road surface conditions. It works on slippery surfaces, even when you brake gently.

 **WARNING: Do not depress the brake pedal repeatedly in quick succession (pumping). Depress the brake pedal firmly and evenly. Pumping the brake pedal reduces the braking effect.**

If the anti-lock braking system operates during braking, the warning light flashes, and the brake pedal pulses as this happens.

When the anti-lock braking system is activated, maintain the force on the brake pedal until the braking situation is over.

 **WARNING: Always adapt your driving style to suit the prevailing road and weather conditions and maintain sufficient distance from other road users and objects on the road.**

Driving Controls

Driving Safety Systems

Anti-lock braking system (ABS) status light



If there is a malfunction with the system, the status light will illuminate. Do not drive your vehicle, contact your McLaren retailer as soon as possible.



WARNING: If the anti-lock braking system malfunctions, brake assist system and electronic stability control are also deactivated. If the anti-lock braking system malfunctions, the wheels could lock when you brake. This may increase the stopping distance and impair your ability to steer.

Brake assist system

Brake assist system operates in emergency braking situations. If you depress the brake pedal quickly, the brake assist system automatically increases the force applied to the brakes and thus shortens the stopping distance.

Continue to depress the brake pedal firmly until the emergency situation is over, the anti-lock braking system prevents the wheels from locking.

When you release the brake pedal, the brakes will work as normal. The brake assist system is deactivated.



WARNING: If the brake assist system malfunctions, the brakes will still operate. However, the braking force is not automatically boosted and this may increase the stopping distance.

Brake disc wiping

Brake disc wiping operates automatically when the windscreen wipers are switched on. It prevents moisture build up on the brake discs during periods of heavy rain, improving braking performance.

Driving Controls

Driving Safety Systems

Hill hold control

If the brake pedal is applied to hold the vehicle on a hill, this function will continue to apply the brakes for 2 seconds after the pedal is released to assist a smooth start.

Brake-steer

Brake steer offers the benefits of a torque vectoring differential, but is integrated into the braking system reducing weight and providing excellent speed of response.

Torque vectoring gives the differential the ability to change the amount of power that is sent to each of the rear wheels to provide optimum stability and traction.

If the system detects that the vehicle is starting to understeer through a corner, the inside rear brake is gently applied. This helps to increase the yaw rate of the vehicle, making the vehicle feel more resistant to understeer. The lateral 'g' force is also increased giving better handling characteristics.

If the driver uses too much throttle exiting a corner, the inside rear wheel increases speed, which without brake steer could cause the vehicle to become unstable. In this situation, brake steer will again gently apply the brake on the inside rear wheel, thereby restoring traction and stability.

Electronic brake pre-fill

If the accelerator pedal is suddenly released, the electronic brake pre-fill function immediately brings the brake pads into contact with the discs, ensuring rapid braking.

Driving Controls

Driving Safety Systems

Electronic stability control (ESC)

Electronic stability control (ESC) monitors driving stability and traction between the tyres and the road surface.

Electronic stability control detects when a wheel starts to spin or the vehicle starts to skid and stabilises the vehicle by braking individual wheels, and/or limiting the engine power output. This also assists when pulling away on wet or slippery road surfaces and stabilises the vehicle when braking.

 **NOTE:** Electronic stability control only functions properly if wheels with the recommended specification tyres are used.

Electronic stability control is activated automatically as soon as the engine is started.

 **WARNING:** If the electronic stability control warning illuminates, do not deactivate electronic stability control. Adapt your driving style to suit road and traffic conditions.

Traction control system

The traction control system is an integral part of electronic stability control.

The traction control system reduces engine torque to prevent the wheels from spinning. If additional intervention is required to stop the wheels from spinning, the vehicle will apply the rear brakes individually. The traction control system brakes individual drive wheels to prevent them from spinning. This means that the vehicle can accelerate on slippery surfaces.

 **WARNING:** The traction control system cannot reduce the risk of an accident if you drive too fast.

Deactivating electronic stability control (ESC)

 **WARNING:** When electronic stability control is deactivated, the risk of the vehicle skidding is increased. Adapt your driving style to suit road and traffic conditions.

 **WARNING:** Do not deactivate electronic stability control unless on a track and prevailing conditions are suitable.

 **NOTE:** When you deactivate electronic stability control, the following conditions result:

- The 'ESC OFF' warning light illuminates
- The light on the 'ESC OFF' button illuminates

- Electronic stability control no longer improves driving stability
- The engine's torque is no longer limited and the drive wheels could spin
- The anti-lock braking system remains activated

Electronic stability control (ESC) Dynamic modes

The level of electronic stability control can be adjusted to various dynamic modes to suit the driver's requirements and is dependent on the handling mode currently active.

Electronic stability control Dynamic modes can be selected at any vehicle speed.

Ensure Sport or Track handling mode is active, see Handling control, page 2.22.

Driving Controls

Driving Safety Systems



Sport Dynamic mode

1. Select Sport handling mode.
The electronic stability control is ON by default.
2. Press the ESC OFF button briefly to activate Sport Dynamic mode which allows more dynamic freedom over the default ESC ON mode.
ESC DYN will be displayed on the Folding Driver Display.

Track Dynamic mode

1. Select Track handling mode.

- The electronic stability control is ON by default.
2. Press the ESC OFF button briefly to activate Track Dynamic mode which allows a further increase in dynamic freedom over Sport Dynamic mode.
ESC DYN will be displayed on the Folding Driver Display.

Variable Drift Control

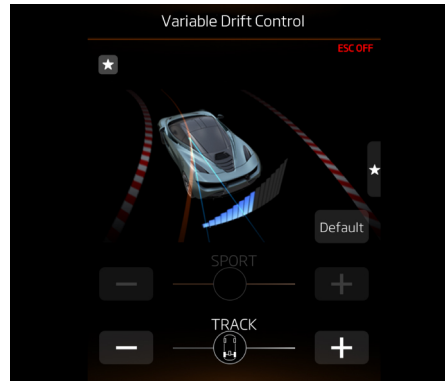

The amount of drift permitted by the ESC in Sport and Track Dynamic modes can be adjusted.

When in Sport Dynamic mode, Track Dynamic mode or ESC off, Variable Drift Control can be accessed on the Central Display. This allows the driver to select the precise level of electronic stability control support that they would like. Select Traction control from the Home menu to access the traction control settings. Select + or - to increase or decrease the amount of drift to suit your preference. Select  to save and manage favourite settings. To reset to factory settings, select Default.

ESC Off

1. Select Sport or Track handling mode.
2. If not already in a ESC Dynamic mode, press the ESC OFF button briefly to activate a ESC Dynamic mode.
3. Press and hold the ESC OFF button for 2 seconds, followed by a confirmation press again within 5 seconds to deactivate the electronic stability control.
ESC OFF will be displayed on the Folding Driver Display and the light on the ESC OFF button will illuminate.

Driving Controls

Driving Safety Systems

Reactivating electronic stability control (ESC)

When electronic stability control is reactivated, the electronic stability control OFF warning light on the Folding Driver Display extinguishes.

- i** NOTE: Electronic stability control is automatically reactivated when the ignition is next switched off and on again.

Reactivation Procedure



Perform any of the following to reactivate electronic stability control:

- Press the ESC OFF button briefly, the light on the button will be extinguished.
- Change the mode on the handling control to Comfort.
- Switch the ignition off and then switch on again.

Airbrake

- !** **WARNING: The driver is responsible for ensuring that no persons, or any part of their body can be trapped during Airbrake movement.**

The Airbrake is located at the rear of your McLaren and moves dynamically, dependent on the vehicle's requirements. A self-test facility that initiates after every full ignition on/off cycle.

- i** NOTE: The Airbrake uses hydraulic pressure and will only operate with the engine running.
- i** NOTE: The Airbrake system is automatically deactivated at low transmission oil temperatures. A warning message will appear on the Folding Driver Display if operation of the Airbrake is selected. The Airbrake system will become active when the transmission oil temperature rises.

Driving Controls

Driving Safety Systems



1. Stowed position
2. Deployed position

Airbrake - AERO button OFF

The Airbrake remains stowed at speeds below 93 mph (150 km/h).

At speeds above 93 mph (150 km/h) the Airbrake deploys, moving dynamically dependent on the vehicle's requirements. This enhances vehicle's high speed stability with increased aerodynamic drag. The Airbrake may actively deploy at speeds below 93 mph (150 km/h) during sudden braking or when high vertical or longitudinal G forces are measured.

Airbrake - AERO button ON

The Airbrake is deployed and moves dynamically, dependent on the vehicle's requirements. This enhances vehicle stability with increased aerodynamic drag. The Airbrake will raise at any vehicle speed.



1. Press the ACTIVE button to switch on the Active Dynamics Panel.



2. Press the AERO button and the Airbrake deploys.
- i** NOTE: The Airbrake may automatically lower to reduce aerodynamic drag in favour of straight line speed if the vehicle is travelling in a straight line at full throttle.

Driving Controls

Driving Safety Systems

Lowering the Airbrake - vehicle moving

If the car is travelling at speeds above 9 mph (15 km/h), press the AERO button, and the Airbrake will lower fully.

 **WARNING: Before lowering the Airbrake, check for any objects which may obstruct movement, e.g. branches or leaves, and remove them or the Airbrake may no longer function correctly. The driver is responsible for ensuring no person or object can be trapped during Airbrake movement.**

-  NOTE: The Airbrake will react to an AERO button press if the speed of the vehicle meets the following criteria:
- When cornering, the vehicle speed must be between 9 mph (15 km/h) and 75 mph (120 km/h).
 - When travelling in a straight line, the vehicle speed must be between 9 mph (15 km/h) and 155 mph (250 km/h).
 - This is to ensure stability of the vehicle while the Airbrake is moving.

Lowering the Airbrake - vehicle stationary

If the car is being parked and the Airbrake is still deployed, press and hold the AERO button for 5 seconds, and the Airbrake will start to lower. Keep the button pressed until the Airbrake is fully lowered, remaining alert to any potential obstructions.

 **WARNING: Before lowering the Airbrake, check for any objects which may obstruct movement, e.g. branches or leaves, and remove them or the Airbrake may no longer function correctly. The driver is responsible for ensuring no person or object can be trapped during Airbrake movement.**

 NOTE: If the AERO button is released before the Airbrake is fully retracted, it will return to the previously selected position.

Airbrake operation

During hard braking at high speed, the Airbrake automatically rises to the fully deployed position to provide maximum braking assistance.

Once the pressure on the brake pedal is released, the Airbrake will return to its previous position.

 NOTE: The Airbrake will lower just before the vehicle comes to a halt during hard braking.

The Airbrake may actively deploy, even if the brake pedal is not depressed, to maintain vehicle stability under the following conditions:

- When high longitudinal G forces are measured, for example, when the accelerator pedal is suddenly released.
- When high vertical G forces are measured, for example, when travelling over the crest of a hill.

 NOTE: The Airbrake may actively deploy to aid engine compartment cooling.

 **WARNING: When activated, the Airbrake will temporarily block the view through the interior mirror. In this case, monitor the traffic behind you through the exterior mirrors.**

Self-test

After each full ignition cycle, the first time the engine is started and at speeds above 9 mph (15 km/h), the Airbrake self-tests, rising and then returning slowly to its initial position.

Driving Controls

Driving Safety Systems

⚠ WARNING: If the Airbrake fails the self-test, a message will appear in the Folding Driver Display. Contact your McLaren Retailer.

i NOTE: If the engine has been stopped with the Airbrake deployed, the self-test procedure will be reversed, i.e. the Airbrake will lower fully then raise to its initial position.

Manual test



1. Press the **ACTIVE** button to switch on the Active Dynamics Panel.



2. Press the **AERO** button. The Airbrake rises and locks in the downforce position.
3. Press and hold the **AERO** button to return the Airbrake to its rest position.

Active central mounted stop lamp - Except 765LT



The active central high mounted stop lamp, located in the Airbrake, will illuminate under braking if the Airbrake is deployed as the Airbrake will obscure the static central high mounted stop lamp.

Driving Controls

Driving Safety Systems

Tyre pressure monitoring system (TPMS)

Prior to every time the vehicle is to be driven, each tyre should be checked when cold and inflated/deflated to the inflation pressure recommended on the tyre pressure label. (If your vehicle has tyres of a different size than the size indicated on the tyre pressure label, you should determine the proper inflation pressure for those tyres).

In certain circumstances it is possible that the tyre pressure monitoring system (TPMS) pressure warning will display without the loss of air from the tyre. This may be due to temperature variations between the locations where the tyre pressure was set and where the vehicle is driven. For example setting pressures in an air conditioned or heated garage and then driving the vehicle outside may induce a tyre pressure warning after a short period of driving. The warning may also display when extreme ambient temperature variations occur or during seasonal temperature changes.



WARNING: Never ignore a tyre pressure warning. Check tyre pressures immediately and if necessary contact your McLaren retailer.

Tyre pressure monitoring system (TPMS) overview



The tyre pressure monitoring system warns you when the pressure drops or the temperature increases above an acceptable level in one or more of the tyres.

The system monitors the tyre pressures and temperatures in each tyre using sensors located in each tyre valve and a receiver located within the vehicle. Communication between the sensors and the receiver is via radio frequency (RF) signals.



NOTE: The tyre pressure monitoring system can suffer interference if you are operating radio transmitting equipment (e.g. radio headphones, two-way radios) in or near the vehicle.



NOTE: The tyre pressure monitoring system will begin transmitting once the vehicle is travelling over 6 mph (10 km/h), there will be a delay of up to 2 minutes before this information is displayed on the Folding Driver Display.

Tyre pressure monitoring system (TPMS) operation



If a low or high tyre pressure or high tyre temperature is detected, the tyre pressure monitoring system warning light will illuminate along with an associated error message on the Folding Driver Display.

Driving Controls

Driving Safety Systems

Stop the vehicle as soon as possible, check all your tyres and inflate them to the recommended pressure, see Tyre pressures, page 6.38. The warning light will be extinguished once the tyres have been inflated to the correct pressure.

Driving on a significantly under-inflated tyre causes the tyre to overheat and can lead to tyre failure. Under-inflation also reduces fuel efficiency and tyre tread life, and may affect the vehicle's handling and stopping ability.

⚠ WARNING: TPMS is not a substitute for proper tyre maintenance, and it is the driver's responsibility to maintain correct tyre pressure, even if under-inflation has not reached the level to trigger illumination of the TPMS low tyre pressure warning light.

Each tyre should be checked weekly when cold and inflated/deflated to the inflation pressure recommended on the tyre pressure label.

Navigate through the 'Vehicle Info' screen on the Folding Driver Display to view the current tyre pressures, see Vehicle info, page 3.07.



The display shows the pressures of each of the four tyres. If the pressure figure appears in green, no action is required. If it appears as red text, inflate the associated tyre to the correct pressure as soon as possible.

Inspect the tyre(s) for any possible causes of reduced tyre pressure.

⚠ WARNING: The tyre pressures indicated on the Folding Driver Display will be more accurate with a pressure gauge. The tyre pressure monitoring system is not a substitute for manually checking tyre pressures or checking for wear and damage. The system only provides a low tyre pressure warning and does not re-inflate the tyres.

The tyre pressure monitoring system cannot alert you to damage to a tyre. Regularly check the condition of your tyres.

⚠ WARNING: If low pressure warnings occur frequently, have the tyres checked at your McLaren retailer. Driving on an under-inflated tyre will cause the tyre to overheat and can lead to tyre failure.

🌿 ENVIRONMENTAL: Under-inflated tyres reduce fuel efficiency and tyre tread life, and may affect the vehicle's handling and braking characteristics.

🌿 ENVIRONMENTAL: Check tyre pressures at least every 7 days.

Driving Controls

Driving Safety Systems

Tyre Temperature Monitoring System operation

If a high tyre temperature is detected, the Tyre Temperature Monitoring System will display an error message on the Folding Driver Display.

Navigate through the 'Vehicle Info' screen on the Folding Driver Display to view the current tyre temperatures, see Vehicle info, page 3.07.



This shows the current temperature of each of the four tyres. If the temperature appears in blue, the tyres have not yet warmed up to optimum operating temperature. If the temperature appears in green, no action is required. If it appears in red, the safe operating temperature of the tyres has been exceeded. Reduce speed or stop the vehicle until the temperatures are at a safe level, i.e. temperatures are displayed in green.

Inspect the tyre(s) for any possible causes of increased tyre temperature.

Driving Controls

Cruise Control

Overview

⚠ WARNING: Pay particular attention to road and traffic conditions, when cruise control is activated, and always travel at a speed which is safe for the current conditions. Never use cruise control on winding or slippery roads or when visibility is poor, e.g. in fog, heavy rain or snow.

Cruise control allows the driver to maintain a constant speed without using the accelerator pedal. This is useful on motorway journeys where a constant speed can be maintained for long periods.



All cruise control functions are operated by the cruise control stalk, positioned on the right of the steering column.

Using cruise control



Accelerate to the desired speed and push the stalk up briefly, to activate cruise control. The set speed will appear on the Folding Driver Display.

i **NOTE:** Cruise control will only operate at speeds in excess of 20 mph (30 km/h).

Speed can be increased at any time by pressing the accelerator pedal. Once the accelerator pedal is released the vehicle will return to the cruise control speed.

Driving Controls

Cruise Control

 **WARNING:** Always be aware that cruise control is engaged and do not override cruise control for extended periods. Releasing the accelerator in these circumstances could lead to the vehicle not decelerating at the rate you expect.

Canceling cruise control



Briefly press the cruise control stalk away from you.

Cruise control is cancelled. The indicator on the Folding Driver Display extinguishes but the last speed set remains stored.

 **NOTE:** The last speed stored is cleared when you switch off the engine.

Cruise control is also cancelled if the foot brake is pressed, if neutral is selected or if active speed limiter is selected.

 **NOTE:** Cruise control is cancelled automatically if electronic stability control detects wheel spin, vehicle skid or if electronic stability control is switched off.

Driving Controls

Cruise Control

Increasing cruise control speed



- A brief press of the stalk upwards will increase the vehicle speed in 1 mph (1 km/h) increments (depending on the units selected, see Distance & Speed unit, page 4.12);
- or press and hold the stalk upwards until the desired speed is reached, then release the stalk;
- or accelerate to the new desired speed and push the stalk up.

Reducing cruise control speed



- A brief press of the stalk downwards will decrease the vehicle speed in 1 mph (1 km/h) decrements (depending on the units selected, see Distance & Speed unit, page 4.12);
- or press and hold the stalk downwards, the vehicle will decelerate, release the stalk when the desired speed has been reached.

i NOTE: If you decelerate using the cruise control stalk, the gearbox may shift down to increase the rate of deceleration. Downshifting manually using the gear change paddles will not disengage cruise control.

Driving Controls

Cruise Control

Resuming a stored speed

 **WARNING:** Only resume the stored speed if it is appropriate for the current road and traffic conditions. Sudden acceleration could endanger yourself and others.



Pull the cruise control stalk briefly towards you. Cruise control will adjust the vehicle's speed to the last speed stored.

Driving Controls

Active Speed Limiter (ASL)

Setting an upper speed limit

- WARNING:** It is the driver's responsibility to keep within proper speed limits.
- WARNING:** The active speed limiter (ASL) feature may allow the vehicle to exceed the upper speed limit in certain situations, for example when descending steep gradients.
- NOTE:** ASL can be activated when the vehicle is stationary. The upper speed limit will be set to a default speed of 20 mph (30 km/h).

The ASL control allows the driver to set an upper speed limit.

Selecting a speed



1. Accelerate or decelerate to the maximum permitted speed and push the stalk down briefly, to activate Active Speed Limiter (ASL).



2. The upper speed limit will appear on the Folding Driver Display.
- NOTE:** The ASL can be overridden by depressing the throttle pedal beyond a predetermined point.

Driving Controls

Active Speed Limiter (ASL)

Cancelling Active Speed Limiter (ASL)



To cancel Active Speed Limiter (ASL) briefly press the stalk away from you. The indicator on the Folding Driver Display will extinguish.

Driving Controls

Running In

Running in

Observe the following running in instructions when the vehicle is new or if any of these components have been replaced.

Engine and gearbox

For the first 625 miles (1,000 km):

- drive at varying road and engine speeds.
- do not drive faster than the maximum speed limit of the road, or 150 mph (240 km/h).
- do not use your vehicle on a track.
- avoid heavy loads on the engine (driving at full throttle).
- avoid driving at engine speeds less than 2,000 rpm.
- avoid running at constant speed and load for long periods.
- avoid using kickdown.
- do not downshift for additional engine braking.
- avoid stopping the engine within 2 minutes of high speed and high load running.

- avoid idling the engine for more than 10 minutes.

After the 625 miles (1,000 km) running in period, you may gradually use the vehicle's full performance.

 **NOTE:** Failure to observe the engine and gearbox operating limits during the running in period may lead to premature wear or damage.

 **NOTE:** These running in instructions also apply for the first 625 miles (1,000 km) after the engine or transmission has been replaced.

 **ENVIRONMENTAL:** This advice will assist in improving fuel economy and should be adopted as normal driving practice even after the running in period.

Brakes

New brakes require an initial bedding in period. Avoid heavy braking situations for the first 625 miles (1,000 km).

Normal/road use

- Allow the engine to warm up before driving at high engine speeds and high loads. Limit engine speed to 5,000 rpm until the engine reaches full operating temperature.
- Avoid stopping the engine within 2 minutes of high speed/high load running.
- Avoid idling the engine for more than 10 minutes.

Driving Controls

Running In

Track use

 NOTE: Do not use the vehicle on a track during the running in period.

Before you use your vehicle on the track, consult your McLaren retailer. McLaren recommend that your vehicle is inspected before and after track use.

Driving Controls

Refuelling

Filling with fuel

⚠ WARNING: Fuel is highly flammable. Fire, naked flames, smoking and using a mobile telephone are prohibited when handling fuels. Switch off the engine before refuelling.

⚠ WARNING: Fuel and fuel vapours can damage your health. Do not inhale fuel vapours or allow fuel to come into contact with skin or clothing.

The fuel filler flap is located at the rear on the left-hand side. It is locked or unlocked automatically when the vehicle is locked or unlocked.

i NOTE: Do not attempt to force the filler flap open if the vehicle is locked. You may damage the flap and its locking mechanism.

i NOTE: The fuel filler flap will remain locked if the engine is running.

Filling on the forecourt

1. Switch off the engine.



2. Press the rear edge of the fuel filler flap, the latch will release.
 3. Open the flap.
- i NOTE: Your vehicle is not fitted with a fuel filler cap.**
4. Insert the nozzle into the fuel filler and dispense fuel. For fuel recommendations, see Recommended fuel, page 2.50.
 5. Do not continue to fill the tank after the pump nozzle switches off.
 6. Remove the nozzle.

7. Close the fuel filler flap, you will hear the latch engage.

Filling with the fuel funnel

1. Switch off the engine.



2. Press the rear edge of the fuel filler flap, the latch will release.
 3. Open the flap.
- i NOTE: Your vehicle is not fitted with a fuel filler cap.**

Driving Controls

Refuelling

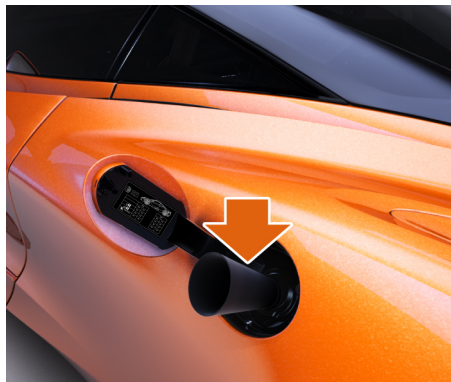

4. Collect the fuel funnel from the vehicle, see Fuel funnel, page 6.14.
5. Insert the fuel funnel fully into the filler neck.
6. Insert the nozzle into the fuel funnel and dispense fuel. For fuel recommendations, see Recommended fuel, page 2.50.
7. Do not overfill.



WARNING: Take care to avoid spillages and overfilling. Ensure any spillages are cleaned immediately.

8. Remove the nozzle.

9. Remove the fuel funnel, clean thoroughly and store in the luggage compartment.
10. Close the fuel filler flap, you will hear the latch engage.

Recommended fuel

For maximum engine performance the use of 98 RON/88 MON unleaded petrol meeting specification EN 228 is required.

In areas where 98 RON/88 MON is unavailable, use unleaded premium grade petrol with a minimum octane rating of 95 RON/85 MON, meeting specification EN 228.



NOTE: Information relating to the quality of fuel being dispensed is displayed on the filling pump.



NOTE: The likelihood of engine wear or damage is increased if fuel does not meet the requirements of EN 228 for unleaded petrol or if fuel additives are used.

Damage caused by use of incorrect fuel is not covered by the vehicle warranty.



NOTE: This vehicle is suitable for use with E10 fuels (10% Ethanol content). This vehicle is not suitable for use with fuels containing more than 10% Ethanol. This vehicle is not fitted with the equipment necessary for the use of fuels containing more than 10% Ethanol.

Driving Controls

Refuelling

Do not use E85 fuels (85% Ethanol content). If E85 fuels are used, serious damage will occur to the engine and fuel system.

 NOTE: If the fuel tank is accidentally filled with the incorrect type of fuel, do not start the engine, and seek qualified assistance.

Driving Controls

Winter Driving

Winter driving

It is recommended that you have your vehicle inspected at your McLaren retailer at the onset of winter. This service includes the following:

- Checking the antifreeze/anti-corrosion concentration
- Adding concentrated cleaning agent to the windscreen washer system
- Checking the battery
- Changing the tyres

Winter tyres

Use winter tyres below 7°C (45°F) and on snow or ice-covered roads. The maximum effect of the anti-lock braking system and electronic stability control systems is only achieved with these tyres.

Use winter tyres of the same make and tread on all wheels to maintain safe handling characteristics. Change the tyre type in 'Vehicle settings' on the Central Infotainment Touchscreen, see Tyre type, page 4.20.

Winter tyres are directional, not asymmetrical, and so must be fitted in accordance with the directional markings on the sides of the tyres.

 NOTE: Only winter tyres specified by McLaren should be used.

 **WARNING: Replace winter tyres with a tread depth of less than 4 mm immediately. They are not suitable for winter use because they do not provide sufficient grip, and could cause an accident.**

 NOTE: A wheel change must be carried out at your McLaren retailer. The vehicle could be damaged if it is jacked up incorrectly.

Consult your McLaren retailer for advice and information regarding the maximum speed specified for the winter tyres fitted. Restrict the maximum speed of the vehicle using the ASL system, see Setting an upper speed limit, page 2.45.

Snow socks

McLaren recommend that you only use snow socks which have been approved for McLaren vehicles. If you are intending to fit snow socks, bear the following points in mind:

- Only ever fit snow socks to both rear wheels.

- Comply with the manufacturer's installation instructions.

Do not exceed the maximum permissible speed as indicated on the snow sock packaging. Remove the snow socks as soon as possible if you are no longer driving on snow-covered roads.

McLaren 

Instruments

Overview.....	3.02
Overview.....	3.02
Tachometer.....	3.02
Speedometer.....	3.03
Folding Driver Display.....	3.04
Overview.....	3.04
Trip info.....	3.06
Vehicle info.....	3.07
Phone.....	3.09
Media.....	3.10
Navigation.....	3.10
Messages.....	3.11
Display window.....	3.18
Gear position indicator.....	3.19
Handling and powertrain display.....	3.19
Electronic stability control (ESC) mode display.....	3.19
Oil temperature.....	3.20
Water temperature.....	3.20
Fuel level and range.....	3.21

Instruments Overview

Overview

The Folding Driver Display is activated when the ignition is switched on, see Switching on the ignition, page 2.03.

⚠ WARNING: No messages will appear on the Folding Driver Display if there is a fault with the screen or vehicle electrics. Contact your McLaren retailer immediately. Use of the vehicle in these circumstances can be dangerous.

Tachometer



The tachometer display appears in the centre of the Folding Driver Display when in Non-Active or Comfort powertrain and handling modes. The red number on the display indicates the engine's maximum RPM.

When Sport or Track powertrain or handling modes are selected, the tachometer style will change to suit the selected mode. See Display window, page 3.18.

i NOTE: The maximum RPM is dynamic and will be reduced under certain conditions, for example, if the engine oil is below normal operating temperature or if neutral gear is selected.

i NOTE: Do not operate the engine at or near its maximum speed for a significant length of time. The fuel supply is cut off to protect the engine when the maximum RPM is reached.

Shift lights

When Track powertrain or handling mode is selected, shift lights will be displayed. The shift lights are arranged in three blocks; a green block, red block and blue block. Each block illuminates as engine RPM increases. Accelerating the engine speed beyond the point that the blue block is illuminated is not conducive to rapid acceleration.

Instruments

Overview

Speedometer



The speedometer is situated centrally on the Folding Driver Display when in Non-Active or Comfort powertrain and handling modes.

When Sport or Track powertrain or handling modes are selected, the speedometer style will change to suit the selected mode. See Display window, page 3.18.

i NOTE: The speedometer changes from mph to km/h when the units are changed from miles to kilometres, see Distance & Speed unit, page 4.12.

i NOTE: The vehicle speed will constantly display '0' if there is a system communication fault. A warning message will appear on the Folding Driver Display to inform you of the fault. Adapt your driving style while this fault exists, you are responsible for the vehicle's speed at all times. Contact your McLaren retailer.

Instruments

Folding Driver Display

Overview

Warnings appear in a pop-up window on the Folding Driver Display.

The stored messages can be viewed at any time when the ignition is on, see Messages, page 3.11.

WARNING: Operating and browsing menus whilst the vehicle is in motion could make you unable to observe road and traffic conditions and could cause an accident.

WARNING: Do not ignore warning messages, failure to take appropriate action may result in personal injury or damage to the vehicle.

Driver Display deployment

The Folding Driver Display can be set to automatically fold down to Slim Display Mode in certain powertrain or handling modes, remain in Slim Display Mode or to remain in Full Display Mode at all times. See Driver Display deployment mode, page 4.18.



The Folding Driver Display deployment mode can be manually changed, using the button located on the dashboard.

If the Folding Driver Display is in Full Display Mode, press the dashboard switch to fold it down to Slim Display Mode. If the Folding Driver Display is in Slim Display Mode, press the dashboard switch to open it to Full Display Mode.

Clock

The clock displays the current time. For more details see Regional settings, page 4.10.

Temperature

WARNING: Even if the temperature displayed is above freezing point, the road surface may still be icy. You should always adapt your driving style and speed to suit the weather conditions.

Temperature is the current outside temperature. There is a short delay before a change in outside temperature is displayed.

When the outside air temperature falls below 3°C (37°F), the frost warning message will be displayed and the temperature reading will change colour after the message has been displayed.

When the outside temperature falls below 0°C (32°F), the ice warning will be displayed.

Instruments

Folding Driver Display

Menu



Navigation through the menu structure is achieved using the control stalk mounted on the left of the steering column.

The following categories are available:

- Trip info, page 3.06
- Vehicle info, page 3.07
- Phone, page 3.09
- Media, page 3.10
- Navigation, page 3.10

Navigate the menu

1. Move the control stalk up or down (**SCROLL + or -**) to highlight your choice.
2. Pull the stalk towards you (**FORWARD**) to enter your selection.
3. Then select the topic of interest from the list, move the control stalk up or down (**SCROLL + or -**) to highlight your choice.
4. Pull the stalk towards you (**FORWARD**) to move through to the next menu in the structure.
5. At the end of each structure there will be a display of information or a screen where a setting can be changed or information viewed.



6. When the function required is selected or a setting is made, pull the stalk towards you (**FORWARD**) to confirm.

Instruments

Folding Driver Display

Trip info



The Folding Driver Display can display the following trip data:

- Trip (since start), page 3.06
- Trip (long term), page 3.06

In order to reset the trip data to zero, select the required option from the menu and pull the stalk towards you (**FORWARD**) to confirm.

Trip (since start)



Displays distance, time, average fuel consumption and average speed for the current journey.

The information will also reset to zero when the engine is switched off for approximately 2 hours.

Trip (long term)



Displays distance, time, average fuel consumption and average speed since the last trip reset.

Odometer

The odometer is shown on each trip screen and displays the total distance the vehicle has travelled.

Instruments

Folding Driver Display

Vehicle info

Overview



The following choices can be made from the Vehicle info screen.

- Message, page 3.07
- Tyre, page 3.07
- Oil status, page 3.08
- Battery, page 3.08
- Servicing, page 3.08
- Vehicle identification, page 3.09

Message



If no error messages have been logged, the display will confirm this.

If any errors have been logged, the screen will display error messages with arrows to scroll through the messages.

Tyre

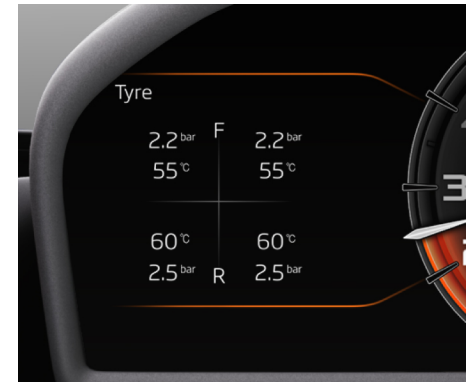

This shows the pressures and temperatures of each of the 4 tyres. If the figures appear in white, no action is required. If they appear as amber or red text, have the tyres inspected and pressures rectified as soon as possible.

Inspect the tyre(s) for any possible causes of reduced pressure or increased temperature.

Instruments

Folding Driver Display

Oil status



Displays a gauge showing the level of oil, together with the oil temperature.

To check the engine oil level, see [Checking the engine oil](#), page 6.04.

Battery

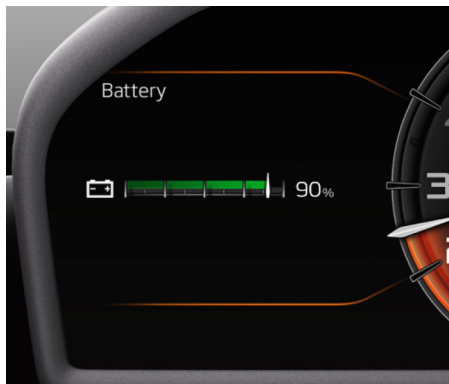

Displays a gauge showing the battery charge status.

To charge the battery, see [Charging the battery](#), page 6.16.

To see how long the vehicle can be parked without the engine running or charging the battery, see [Parking days](#), page 2.02.

Servicing



At approximately 30 days or 625 miles (1,000 km) before a service is due, the above display appears.

The message will then appear every time the ignition is switched on, with the time/distance figures reducing. Once the service has been carried out, the display will be reset by your McLaren retailer.

If a service becomes overdue, the display will show the distance by which it is overdue.

Instruments

Folding Driver Display

Vehicle identification



Displays the vehicle identification number (VIN).

Phone



Pull the stalk towards you (FORWARD) to access further options.

The following options are available:

- Redial
- Favourites
- History

For more information on pairing and setting up a phone, see Phone, page 4.25.

i NOTE: The available options within the phone menu may depend on your model of phone and previous calls made or received while connected to your McLaren.

Instruments

Folding Driver Display

Media



Details of the track or radio station currently playing will be displayed.

Pull the stalk towards you (**FORWARD**) to access further options.

The following options are available:

- Play
- Pause
- Next
- Previous

For more information on accessing media from different sources, see Media, page 4.32.

i NOTE: The available options within the media menu may depend on source which is currently playing.

Navigation



The current navigation turn-by-turn guidance will be displayed on the Folding Driver Display if route guidance has been started using the Central Infotainment Touchscreen.

For more information on setting a route and using the navigation feature, see Navigation, page 4.37.

The turn-by-turn display provides the following information:

1. Next turn direction and distance
2. Total distance to destination remaining

Instruments

Folding Driver Display

3. Total time to destination remaining

i NOTE: If no destination has been set using the Central Infotainment Touchscreen, only the compass and current road name will be displayed.

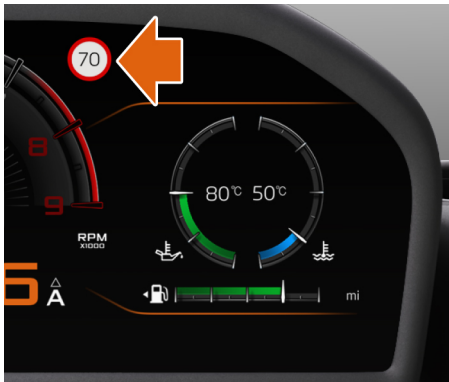

If available, the speed limit for the current road will be displayed on the Folding Driver Display.

i NOTE: The speed limit is for guidance only, always observe local speed limit information as there may be temporary or new speed restrictions in place.

Messages

The Folding Driver Display may show messages that refer you to the Owner's Handbook.

The icon displayed with the message indicates the severity.

i Information that does not require action to be taken.

i Information that requires action to be taken.

! Low risk fault information.

! High risk fault information.

i NOTE: Some messages may have different icons indicating that there is a fault with a specific function.

Some messages advise you to consult the Owner's Handbook. The table below indicates what you should do when one of these messages is displayed.

! **WARNING: Do not ignore warning messages, failure to take appropriate action may result in injury or damage to the vehicle.**

Instruments

Folding Driver Display

Messages - 720S Coupe and Spider, 765LT Coupe and Spider

Message	Action
Brake fluid level low	Top up brake fluid, see Brake fluid, page 6.10.
Steering fluid level low	Top up the power steering fluid, see Power steering fluid, page 6.09.
Front left tyre pressure low	Stop the vehicle and inspect wheels and tyres, see Inspecting wheels and tyres, page 6.37.
Front right tyre pressure low	Stop the vehicle and inspect wheels and tyres, see Inspecting wheels and tyres, page 6.37.
Rear left tyre pressure low	Stop the vehicle and inspect wheels and tyres, see Inspecting wheels and tyres, page 6.37.
Rear right tyre pressure low	Stop the vehicle and inspect wheels and tyres, see Inspecting wheels and tyres, page 6.37.
Clutch over temperature	The vehicle has been subject to extreme operating conditions. This may be caused by excessive hill starts, repeated hard acceleration, driving slowly up steep hills for extended periods. As a result, the gearbox may limit engine torque. Stop the vehicle and allow the engine to idle in neutral for a few minutes.
Clutch temperature high	The vehicle has been subject to extreme operating conditions. This may be caused by excessive hill starts, repeated hard acceleration, driving slowly up steep hills for extended periods. As a result, the gearbox may limit engine torque. Stop the vehicle and allow the engine to idle in neutral for a few minutes.
ESC OFF not possible	The ESC deactivation conditions have not been met, see Electronic stability control (ESC), page 2.32.
Front left tyre over inflated	Stop the vehicle and inspect wheels and tyres, see Inspecting wheels and tyres, page 6.37.

Instruments

Folding Driver Display

Message	Action
Front right tyre over inflated	Stop the vehicle and inspect wheels and tyres, see Inspecting wheels and tyres, page 6.37.
Rear left tyre over inflated	Stop the vehicle and inspect wheels and tyres, see Inspecting wheels and tyres, page 6.37.
Rear right tyre over inflated	Stop the vehicle and inspect wheels and tyres, see Inspecting wheels and tyres, page 6.37.
ESC Reduced not possible	The ESC reduction conditions have not been met. See Electronic stability control (ESC), page 2.32.
Launch Mode unavailable	The conditions to enable a Launch have not been met, see Launch control, page 2.26.
Launch Mode aborted	See Launch control, page 2.26.
Cruise control unavailable at current vehicle speed	See Using cruise control, page 2.41.
Front left tyre over temperature	Stop the vehicle and inspect wheels and tyres, see Inspecting wheels and tyres, page 6.37.
Front right tyre over temperature	Stop the vehicle and inspect wheels and tyres, see Inspecting wheels and tyres, page 6.37.
Rear left tyre over temperature	Stop the vehicle and inspect wheels and tyres, see Inspecting wheels and tyres, page 6.37.
Rear right tyre over temperature	Stop the vehicle and inspect wheels and tyres, see Inspecting wheels and tyres, page 6.37.
Battery management active	The vehicle is not be able to supply enough voltage and has activate power saving mode. The climate control and steering will operate with reduced effect. See Power saving mode, page 2.02.
Key battery critically low	See Replacing key fob battery, page 6.32.

Instruments

Folding Driver Display

Message	Action
Key battery low	See Replacing key fob battery, page 6.32.
Windscreen washer fluid low	Top up windscreen washer fluid, see Windscreen washers, page 6.11.
Airbrake system temporarily unavailable	See Airbrake, page 2.34.
Airbrake temporarily inhibited	See Airbrake, page 2.34.

Instruments

Folding Driver Display

Messages - 720S and 765LT Spider Only

Message	Action
Roof failure	Message is displayed if there is an operational malfunction. Roof operation will be inhibited. Please contact your McLaren retailer.
Confirm tonneau empty	Message is displayed if the tonneau cover has been opened at any time whilst the roof has been raised and the roof or backlight switches have been pressed down to the lower (open) position. By releasing the switch and pressing OK on the menu control stalk, you confirm the tonneau area is empty and you accept if this is not the case that damage may occur to the retractable roof or backlight during operation. The roof or backlight will begin to lower (open) once the respective switch is pressed. See Retractable Roof - Spider models, page 1.15, Backlight - Spider models , page 1.19.
Roof operation unavailable Vehicle speed too high	Message is displayed if the vehicle has exceeded 31 mph (50 kph) during an open/close cycle. Reduce the vehicle speed and operate the roof switch in the desired direction. See Retractable Roof - Spider models, page 1.15.
Roof operation unavailable Doors closed	Message is displayed if the roof control unit is unable to confirm door status. Roof operation will be inhibited until the door status can be confirmed. Please contact your McLaren retailer.
Roof operation unavailable Engine start required	Message is displayed if the vehicle battery charge has become too low. Start the engine and allow the battery to be charged. Operate the roof switch in the desired direction. Please contact your McLaren retailer.
Roof operation unavailable Ambient temperature too low	Message is displayed if the ambient temperature falls below -20°C (-4°F) when an open/close cycle is attempted. See Roof Operating Temperature, page 1.16.

Instruments

Folding Driver Display

Message	Action
Roof operation in progress	Message is displayed during a roof open/close cycle. See Retractable Roof - Spider models, page 1.15.
Roof open	Message is displayed when the roof has completed the stow (open) cycle. See Retractable Roof - Spider models, page 1.15.
Roof closed	Message is displayed when the roof has completed the raise (close) cycle. See Retractable Roof - Spider models, page 1.15.
Tonneau operation incomplete	Message is displayed when the tonneau cover has been stopped in an intermediate position during an open/close cycle. Operate the tonneau switch in the desired direction. See Tonneau Cover - Spider models , page 1.20 and Retractable Roof - Spider models, page 1.15.
Tonneau operation in progress	Message is displayed during tonneau cover open/close cycle. See Tonneau Cover - Spider models , page 1.20.
Tonneau open	Message is displayed when the tonneau has completed the open cycle. See Tonneau Cover - Spider models , page 1.20.
Tonneau closed	Message is displayed when the tonneau has completed the close cycle. See Tonneau Cover - Spider models , page 1.20.
Roof system over temperature	Message is displayed if the roof electrical system has become too hot. Roof operation will be inhibited until the system cools to allow safe operating level. Please contact your McLaren retailer.
Roof operation incomplete	Message is displayed when the tonneau cover has been stopped in an intermediate position during a open/close cycle. Operate the tonneau switch in the desired direction. See Retractable Roof - Spider models, page 1.15.

Instruments

Folding Driver Display

Message	Action
Electrochromic glass roof switch fault	Message is displayed if there is a operational malfunction. Electrochromic roof operation will be inhibited. Please contact your McLaren retailer.
Electrochromic glass roof fault	Message is displayed if there is a operational malfunction. Electrochromic roof operation will be inhibited. Please contact your McLaren retailer.

Instruments

Folding Driver Display

Display window

Non-Active/Comfort mode



The display window provides the driver with visual access to the control settings and current performance values of the vehicle. The Folding Driver Display, as indicated above, is displayed when the vehicle is in Non-Active/Comfort mode.

The information displayed on the centre section of the Folding Driver Display will change dependent on the mode selected. See Sport mode, page 3.18 and Track mode, page 3.18.

Sport mode



The display window provides the driver with visual access to the control settings and current performance values of the vehicle. The Folding Driver Display, as indicated above, is displayed when the vehicle is in Sport mode.

The information displayed on the centre section of the Folding Driver Display will change dependent on the mode selected. See Non-Active/Comfort mode, page 3.18 and Track mode, page 3.18.

Track mode



The display window provides the driver with visual access to the control settings and current performance values of the vehicle. The Folding Driver Display, as indicated above, is displayed when the vehicle is in Track mode.

The information displayed on the centre section of the Folding Driver Display will change dependent on the mode selected. See Non-Active/Comfort mode, page 3.18 and Sport mode, page 3.18

For more information regarding shift lights see Shift lights, page 3.02.

Instruments

Folding Driver Display

Gear position indicator



The gear indicator shows the current gear position selected: Neutral, Gear 1-7, or Reverse. The indicator will also show A or M depending on whether automatic or manual mode is selected.

The gear position indicator moves to the centre of the Folding Driver Display, swapping position with the speedometer, when the vehicle is in Sport or Track mode. See Sport mode, page 3.18 and Track mode, page 3.18.

For more information, see Manual/automatic mode, page 2.18.

Handling and powertrain display



Confirmation that the ACTIVE button has not been pressed (Active Dynamics Panel is off), the handling and powertrain displays will both show Non-Active and will be displayed in white. The mode will not be implemented if all pre-conditions are not met, if the handling and powertrain mode selected is displayed. For more information on the different settings that are available, see Active dynamics control, page 2.21.

Electronic stability control (ESC) mode display



Confirmation of the electronic stability control mode selected is displayed. For more information on the different settings that are available, see Active dynamics control, page 2.21.

Instruments

Folding Driver Display

Oil temperature

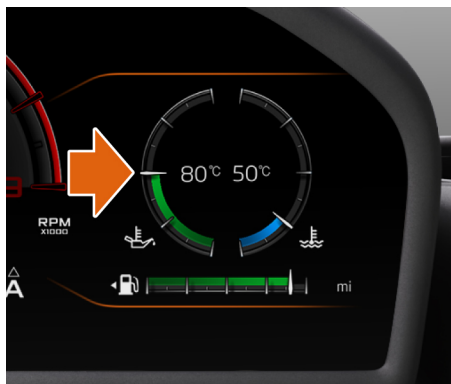

The oil temperature is displayed in the form of a coloured gauge on the right-hand side of the Folding Driver Display.

When the engine is first started the gauge will be BLUE. As the engine warms up, the colour will change to GREEN, indicating normal temperature.

High temperature is indicated if the gauge turns AMBER and excessive temperature is indicated by the gauge turning RED.

If the gauge shows high temperature, AMBER, slow down until the temperature drops to normal. If the temperature continues to rise and the gauge turns RED, a warning message will appear on the Folding Driver Display.

Stop the vehicle as soon as safety permits and contact your McLaren retailer immediately.

Water temperature

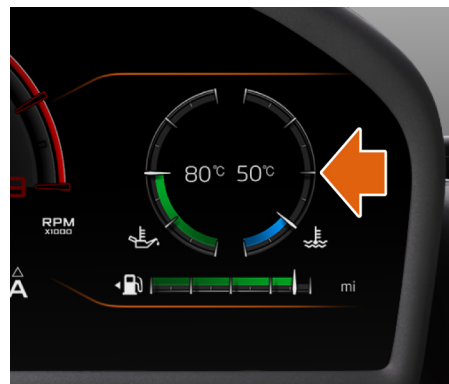

The water temperature is displayed in the form of a coloured gauge on the right-hand side of the Folding Driver Display.

When the engine is first started the gauge will be BLUE. As the engine warms up, the colour will change to GREEN, indicating normal temperature.

High temperature is indicated if the gauge turns AMBER and excessive temperature is indicated by the gauge turning RED.

Instruments

Folding Driver Display

If the gauge shows high temperature, AMBER, slow down until the temperature drops to normal. If the temperature continues to rise and the gauge turns RED, a warning message will appear on the Folding Driver Display.

Stop the vehicle as soon as safety permits and contact your McLaren retailer.

Fuel level and range

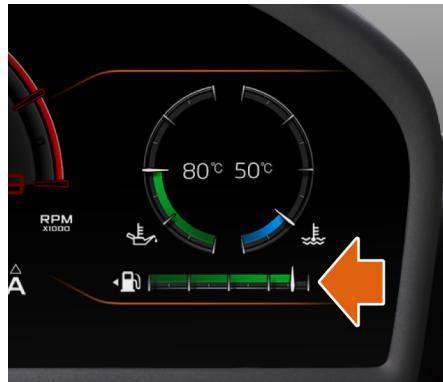

Fuel level

The fuel level is displayed in the form of a gauge on the right-hand side of the Folding Driver Display.

Fuel range

Range is the estimated distance until the vehicle requires refuelling.

McLaren 

Central Display

Introduction.....	4.04
Copyright.....	4.04
Other information.....	4.04
System controls.....	4.04
Overview.....	4.06
Settings.....	4.08
Overview.....	4.08
General settings.....	4.08
Regional settings.....	4.10
Connection settings.....	4.13
Sound settings.....	4.14
Radio & media settings.....	4.15
Bluetooth phone settings.....	4.16
Light settings.....	4.16
Vehicle.....	4.17
Navigation.....	4.22
Cameras.....	4.24
Garage door opener settings.....	4.24
Phone.....	4.25
Overview.....	4.25
Device pairing.....	4.26
Making a call.....	4.28
Receiving a call.....	4.29
In-call options.....	4.30
Ending a call.....	4.30
Contacts.....	4.30

Media.....	4.32
Overview.....	4.32
Media controls.....	4.33
Connecting an external device.....	4.34
USB and iPod.....	4.34
Storage.....	4.35
Bluetooth audio.....	4.36
AUX.....	4.36
Navigation.....	4.37
Overview.....	4.37
Safety.....	4.37
Using Navigation.....	4.38
Setting a destination.....	4.39
Radio.....	4.41
Overview.....	4.41
Radio controls.....	4.41
Radio data system (RDS).....	4.42
McLaren Track Telemetry.....	4.43
Overview.....	4.43
Opening the application.....	4.43
Setup.....	4.44
Drive.....	4.44
Ending your session.....	4.46
Reviewing your data.....	4.46
Importing telemetry data.....	4.47
Exporting telemetry data.....	4.47
Editing a track.....	4.48

Central Display

Garage Door Opener.....	4.49
Overview.....	4.49
Voice Recognition.....	4.51
Overview.....	4.51

Central Display Introduction

Copyright

McLaren Automotive is constantly updating the systems covered within this document, and therefore reserves the right to change the specification without notice at any time.

Every attempt is made to ensure that this information is totally accurate, however no liabilities for inaccuracies or the resulting consequences are accepted by McLaren Automotive or its Retailers, except in the case of personal injury caused by the negligence of these parties.

Other information

The Wi-Fi trademark is owned by the “Wi-Fi Alliance” trade association. A manufacturer may use the “Wi-Fi” trademark to indicate that their certified product belongs to a class of wireless local area network (WLAN) devices based on the IEEE 802.11 standards.

The Bluetooth® word mark and logos are owned by the Bluetooth® SIG Inc., and any use of such marks by McLaren Automotive Ltd. is under licence. Bluetooth QDID: B019632; B017641; B017642.

Other trademarks and trade names are those of their respective owners.

System controls

When the ignition is switched on, the McLaren Infotainment System (MIS) will start up and resume the previously used audio source if available. If the previously used source is not available, the MIS will display the home screen. If it was previously in standby mode, it will resume in standby mode displaying the time and date.



Press the  to fully start the MIS and show the home screen.

Central Display Introduction



1. Home, on/standby
2. Volume
3. Climate control
4. Media
5. Mute
6. Phone
7. Radio
8. Navigation

Home, on/standby



To switch the MIS on, press the home button (1).

When the MIS is on, a brief press of the button will return you to the home screen from anywhere in the system.

Press and hold the home button for three seconds to switch the MIS into standby mode. To switch from standby mode to on, simply press the home button.

To use the MIS when the vehicle's Ignition is off, press and hold the home button for one second to access Timer mode. In this mode the MIS will shut down after 15 minutes if not extended by the user.

Volume

Rotate the control (2) clockwise to increase volume or anti-clockwise to reduce the volume.

A horizontal bar representing the volume setting will appear briefly on the screen.

Use the volume control to set the volume of the source that is currently active. The name of the active source will appear on the screen.

If the Mute button (5) has been used (See Mute, page 4.05), rotating the volume control in either direction will restore the sound.



NOTE: You can adjust any volume source by rotating the volume control dial. For temporary sources of audio (phone calls), this can be adjusted using the dial when the source is active.

Climate control



Press the Climate Control button (3) to access the Climate Control system directly. See Climate Control, page 5.04.

Media



Press the Media button (4) to access any stored or connected media. See Media, page 4.32.

Mute



Press button (5) to mute all sound from the system. The mute symbol will be briefly displayed on the screen.

Press again to restore the sound. The sound can also be restored by rotating the volume control (2) in either direction.

Phone



Press button (6) to access the Phone function. See Phone, page 4.25.

Central Display Introduction

Radio



Press button (7) to access the Radio. See Radio, page 4.41.

Navigation



Press the Navigation button (8) to launch the navigation function directly. See Navigation, page 4.37.

Back



Press the on-screen back button to return to the previous screen. The function of this button is contextual and will change according to the currently selected system and the active feature.

Status Bar

A number of icons will appear at the top of the screen, when certain systems are in operation or features are active.



Phone signal strength indicator.



The Bluetooth® icon will be displayed in white when a device is connected. If no Bluetooth® device is connected the icon will not be displayed.

The following icons will be displayed in combination with the connected media device and integrated media system icons to indicate their status:



Media playing



Media paused



Media muted

Overview

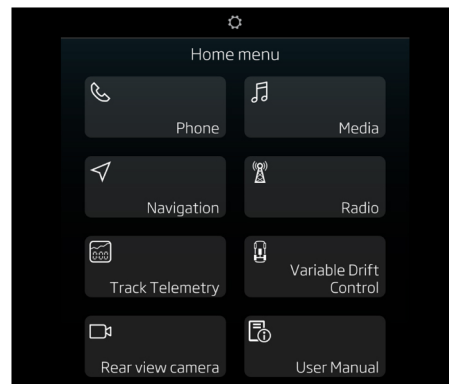



Touch the icon representing the feature that you wish to access.

- Settings, page 4.08
- Phone, page 4.25
- Media, page 4.32
- Navigation, page 4.37
- Radio, page 4.41
- 360 Park Assist, page 2.15
- Electronic stability control (ESC), page 2.32

Central Display Introduction

- Rear view camera (RVC), page 2.14
- Electronic user manual, page 3

 NOTE: The features available may vary depending on the vehicle specification.

 NOTE: Some features and icons on the McLaren Infotainment System (MIS) may be present but not functional, based on the options selected for your unique vehicle.

Central Display Settings

Overview

From the Home menu, press the  icon to display the Settings menu.

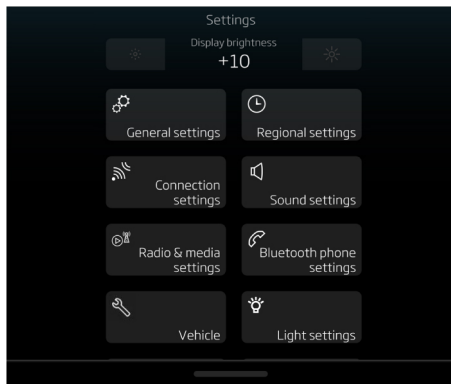

The following choices can be made from the Settings screen:

- General settings, page 4.08
- Regional settings, page 4.10
- Connection settings, page 4.13
- Sound settings, page 4.14
- Radio & media settings, page 4.15
- Bluetooth phone settings, page 4.16

- Vehicle, page 4.17
- Light settings, page 4.16
- Navigation, page 4.22
- Cameras, page 4.24

 **NOTE:** The settings available may vary depending on the vehicle specification.

General settings

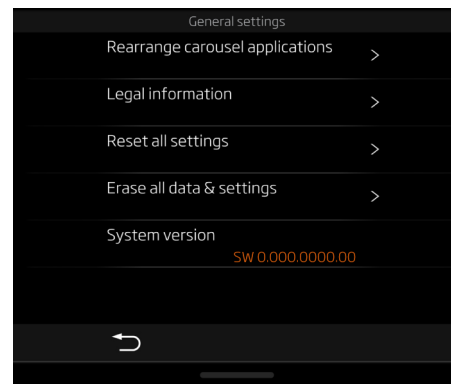

The following general settings are available:

- Rearrange carousel applications, page 4.09
- Legal information, page 4.09
- Reset all settings, page 4.09
- Erase all data & settings, page 4.09
- System version, page 4.09

Central Display Settings

Rearrange carousel applications

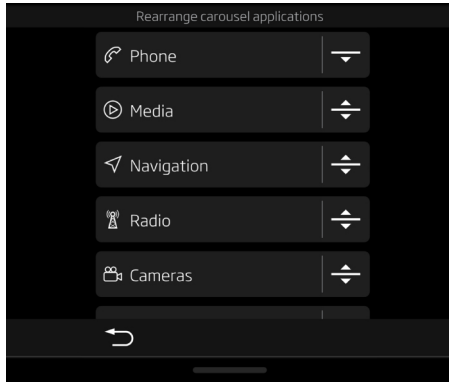

The order in which the applications are shown on the home screen can be rearranged to suit your preference.

Touch an application you wish to move and drag it to another position in the list.

Legal information

Select this option to view the available legal information relating to your vehicle and the McLaren Infotainment System (MIS).

Reset all settings

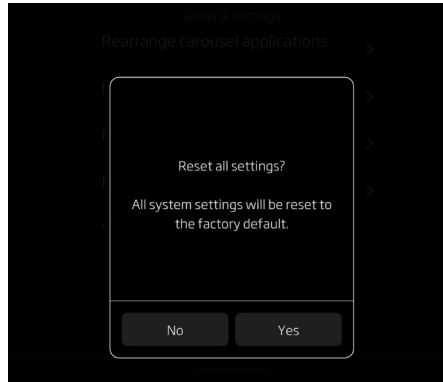

Select Yes to reset all vehicle and the MIS settings to the factory default.

Erase all data & settings

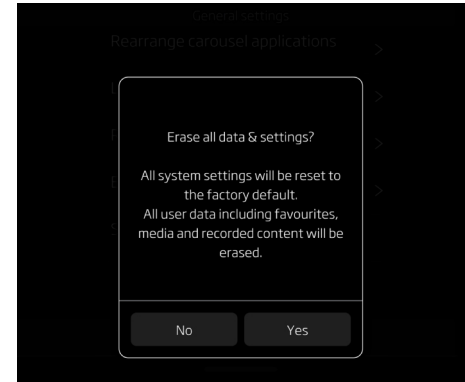

Select Yes to erase all data and reset all vehicle and the MIS settings to the factory default.

System version

Displays the software version installed on the MIS.

Central Display Settings

Regional settings

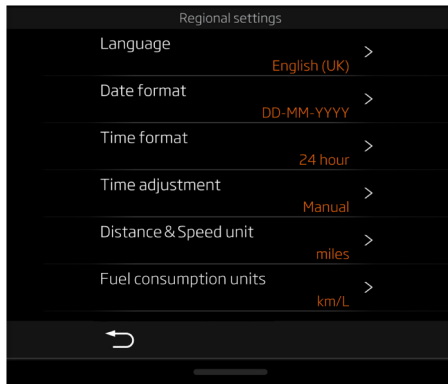

The following regional settings are available:

- Language, page 4.10
- Date format, page 4.11
- Time format, page 4.11
- Time adjustment, page 4.11
- Distance & Speed unit, page 4.12
- Fuel consumption units, page 4.12
- Temperature units, page 4.12
- Pressure units, page 4.13

Language

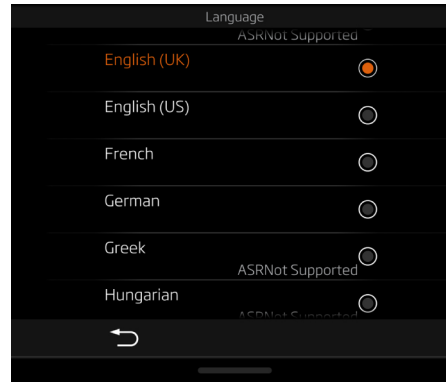

Use this screen to set your preferred language.

The following choices are available:

- Arabic (Saudi)
- Chinese (Cantonese)
- Chinese (Mandarin)
- Czech
- Dutch
- English (Australia)
- English (UK)
- English (US)

- French
- German
- Greek
- Hungarian
- Italian
- Polish
- Portuguese (Brazil)
- Russian
- Spanish
- Thai
- Turkish

Central Display Settings

Date format

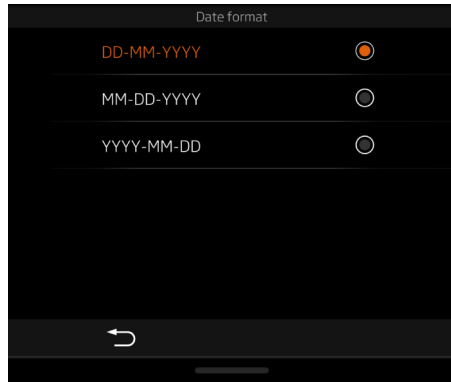

Select from the following date formats:

- DD-MM-YYYY
- MM-DD-YYYY
- YYYY-MM-DD

Time format

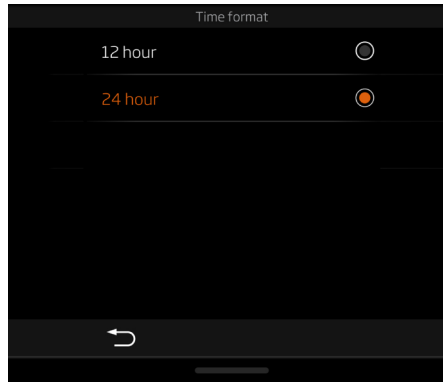

Select 12 hour or 24 hour format.

Time adjustment

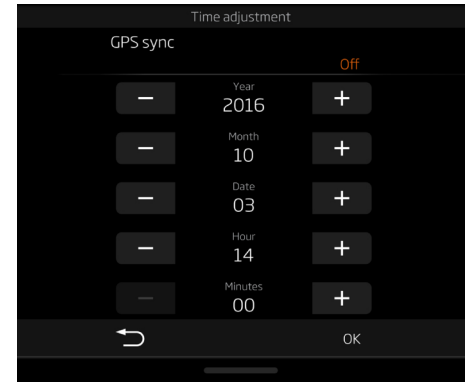

Select GPS sync to automatically adjust the time using the GPS signal. On will be highlighted when GPS sync is activated.

GPS sync must be set to Off before the time can be manually adjusted.

Central Display Settings

Distance & Speed unit

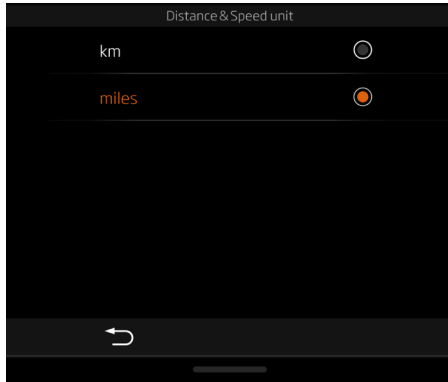

Select km or miles.

Fuel consumption units



Select L/100km, km/L, mpg (UK) or mpg (US).

Temperature units

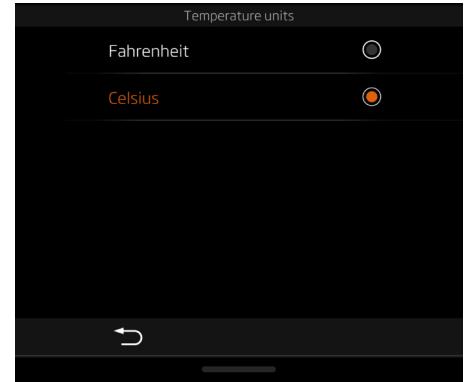

Select Fahrenheit or Celsius.

Central Display Settings

Pressure units

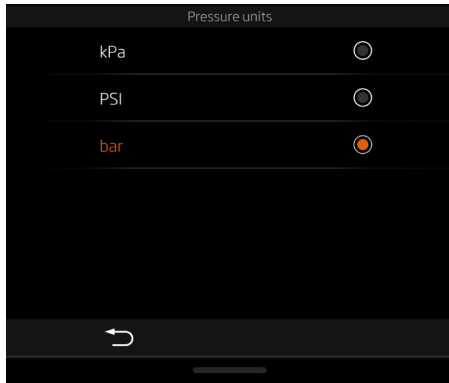

Select kPa, PSI or bar.

Connection settings

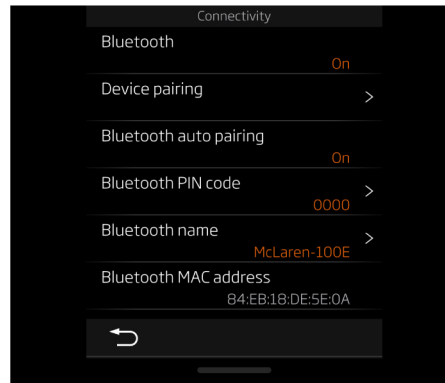

The following connection settings are available:

- Bluetooth, page 4.13
- Device pairing, page 4.26
- Bluetooth auto reconnect, page 4.13
- Bluetooth PIN code, page 4.13
- Bluetooth name, page 4.13
- Bluetooth MAC address, page 4.13

Bluetooth

Touch Bluetooth to toggle the function On and Off.

Bluetooth auto reconnect

When On is selected, a paired Bluetooth® device will automatically reconnect to the Folding Driver Display when in range. If Off is selected, the device will have to be manually connected each time.

Bluetooth PIN code

Select this option to view or change the Bluetooth® PIN code using the on-screen keyboard. By default, the code is set to 0000.

Bluetooth name

Select this option to view or change the Bluetooth® name using the on-screen keyboard.

Bluetooth MAC address

Select this option to view the Bluetooth® MAC address.

Central Display Settings

Sound settings

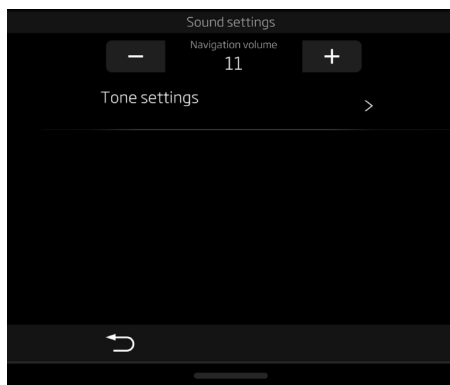

The following sound settings are available:

- Navigation volume, page 4.14
- Tone settings, page 4.14
- Bowers & Wilkins modes, page 4.14

Navigation volume

Adjust the navigation volume to the desired level using the + or - icons adjacent to Navigation volume. The range is 0 to +15 in increments of 1.

Tone settings

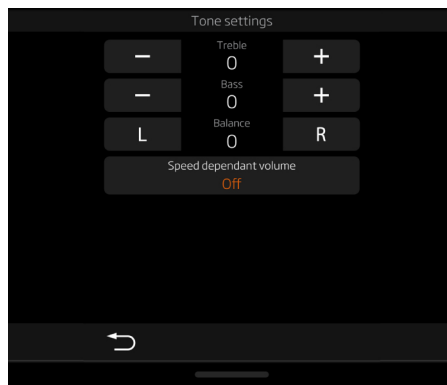

The sound settings apply to all functions of the McLaren Infotainment System (MIS).

i NOTE: Tone settings can also be accessed from Radio and each system within Media by pressing the  icon.

Treble

Touch the + or - icons adjacent to treble to achieve the desired sound reproduction quality. The range is 0 to +9 or 0 to -9 in increments of 1.

Bass

Touch the + or - icons adjacent to bass to achieve the desired sound reproduction quality. The range is 0 to +9 or 0 to -9 in increments of 1.

Balance

Touch the + or - icons adjacent to balance to achieve the desired sound from the speakers. The range is 0 to L9 or 0 to R9 in increments of 1.

Speed dependent volume

This feature increases the volume setting at higher vehicle speeds to compensate for the background mechanical noise.

Repeatedly touch the icon to change between Off, 1, 2, and 3. Select the setting which offers the optimum sound reproduction.

Bowers & Wilkins modes

The following modes are available with the Bowers & Wilkins audio system:

- Studio (default mode) - True sound. As the artist intended.
- Driver Focus - Optimised listening for driver seat.
- On Stage - Surround Sound Envelopment.

Central Display Settings

Radio & media settings

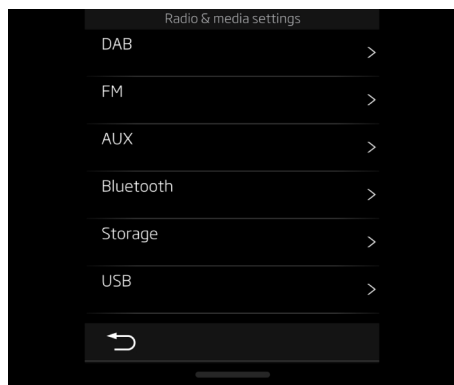

The following radio and media settings are available:

- DAB, page 4.15
- FM (RDS), page 4.15
- AUX, page 4.15
- Bluetooth phone settings, page 4.16
- Storage, page 4.15
- USB, page 4.15

DAB

L-Band tuning can be set to **On**, if available in your country.

Set DAB-DAB linking to **On** to enable automatic tuning to alternative DAB broadcasts when reception of the currently tuned DAB station is reduced or lost.

Set DAB-FM linking to **On** to enable automatic tuning to alternative FM broadcasts when reception of the currently tuned DAB station is reduced or lost.

Enable DAB related services by selecting **On**.

Select **Off** to deactivate any feature.

FM (RDS)

Radio Data System (RDS) is a system which allows digital data to be sent to radio receivers at the same time as the FM signal.

The AF feature automatically selects the strongest signal for radio reception. As your vehicle moves away from one transmitter and nearer to another, AF will switch transmitters to maintain the best reception possible. Set AF Search to **On** to enable this feature. Select **AF Reg** to limit the alternative frequency searching to regional transmissions. Select **Off** to deactivate.

Traffic Program (TP) interrupts radio and media playback to inform the driver of traffic conditions. Touch Auto TP seek to toggle between **On** and **Off** to activate or deactivate this feature.

AUX

Select this option to adjust the input gain from the analogue audio signal.

Storage

Select this option to view available storage space, manage files and erase files stored on the McLaren Infotainment System (MIS).

USB

Select this option to view and manage files stored on any connected USB device.

Central Display Settings

Bluetooth phone settings

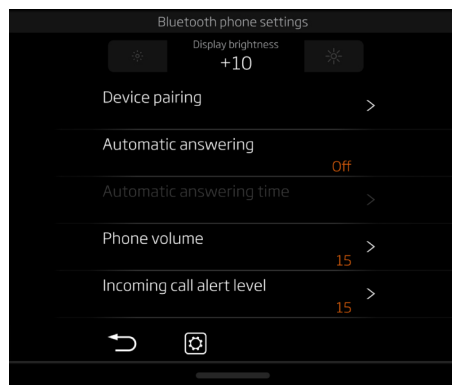

The following Bluetooth® phone settings are available:

- Device pairing, page 4.26
- Automatic answering, page 4.16
- Phone volume, page 4.16
- Incoming call alert level, page 4.16
- Microphone level, page 4.16
- Sort by, page 4.16

Automatic answering

Select this feature to enable the McLaren Infotainment System (MIS) to automatically answer an incoming call. Adjust the time delay before automatic answering occurs using the + or - icons. The range is 1 to 30 seconds, in increments of 1.

Phone volume

Adjust the phone volume to the desired level using the + or - icons. The range is 0 to +40 in increments of 1.

Incoming call alert level

Adjust the incoming call alert volume to the desired level using the + or - icons. The range is 0 to +40 in increments of 1.

Microphone level

Adjust the microphone level using the + or - icons. The range is -10 to +10 in increments of 1.

Sort by

Select whether your contacts are sorted by first name or last name.

Light settings

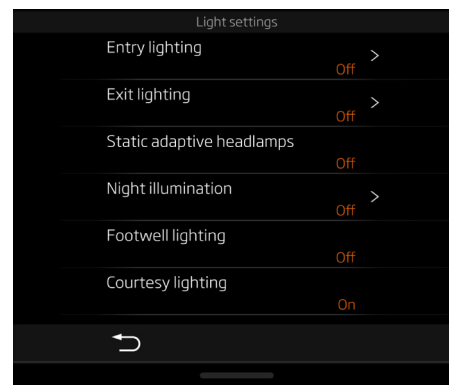

Entry and exit lighting illuminates the exterior lights when the vehicle is unlocked and locked. To activate these features, set the duration of each to **15 seconds**, **30 seconds**, **45 seconds** or **60 seconds**. To deactivate, select **Off**.

The Static Adaptive Headlamps adjust the beams when cornering, providing improved illumination in the direction of travel. Set Static Adaptive Headlamps **On** to activate this feature, to deactivate, select **Off**.

Central Display Settings

Night illumination provides low level interior lighting when the headlamps are on. To activate, select the desired level from the range of 1 to 7. To deactivate, select **Off**.

Footwell and courtesy lighting can be set to **On** or **Off** as desired.

Select ambient lighting, select **On** to activate this feature, then adjust the colour and intensity as required.

Vehicle

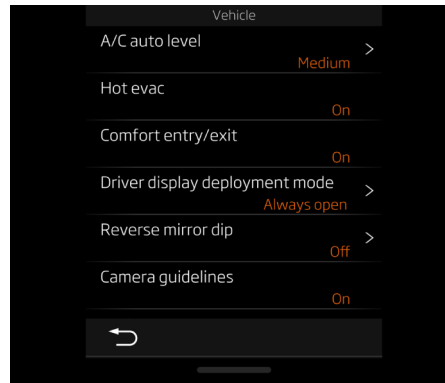

The following vehicle settings are available:

- A/C auto level, page 4.17
- Hot Evac, page 4.18
- Comfort entry/exit, page 4.18
- Driver Display deployment mode, page 4.18
- Reverse mirror dip, page 4.18
- Camera guidelines, page 4.19
- Performance Shift Cue (PSC), page 4.19
- Auto alarm, page 4.19

- Automatic door locking, page 4.19
- Automatic mirror folding, page 4.19
- Door unlock, page 4.20
- Silent door lock, page 4.20
- Tyre type, page 4.20
- Valet mode, page 4.20
- Wiper mode, page 4.21
- Wiper sensitivity, page 4.21
- Speed limit display, page 4.21

A/C auto level

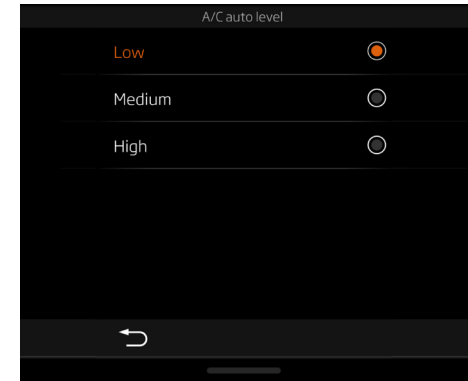

Central Display Settings

The A/C auto level selected will have an effect on the fan speed used by the climate control system, when in AUTO mode.

Select **Low**, **Medium** or **High** to suit your preference.

Hot Evac

Select **On** to activate Hot Evac, see Hot Evac, page 5.06.

Select **Off** to deactivate this feature.

Comfort entry/exit

When comfort entry/exit is **On**, the driver's seat will move fully rearwards and to its lowest position and the steering wheel will move inwards and to its highest position when the engine is off and the driver's door is opened.

When comfort entry/exit is **Off**, the driver's seat and steering wheel will remain in position at all times.

Driver Display deployment mode

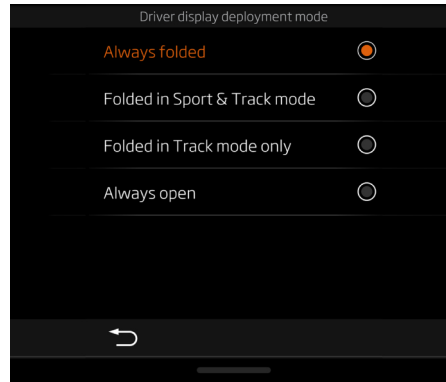

The Folding Driver Display can be set to automatically fold down to Slim Display Mode in certain powertrain or handling modes, remain in Slim Display Mode or to remain in Full Display Mode at all times.

When **Always folded** is selected, the Folding Driver Display will stay in Slim Display Mode.

When **Folded in Sport and Track mode** is selected, the Folding Driver Display will fold down to Slim Display Mode in either Sport or Track powertrain or handling modes.

When **Folded in Track mode only** is selected, the Folding Driver Display will fold down to Slim Display Mode in Track powertrain or handling modes.

When **Always open** is selected, the Folding Driver Display will stay in Full Display Mode.

Reverse mirror dip

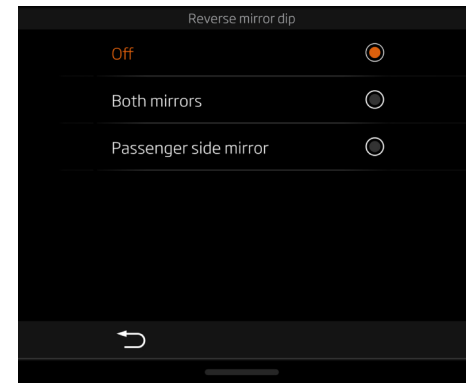

Select **Off**, **Both mirrors** or **Passenger side mirror**.

Off - no mirror dip will occur when reverse is engaged.

Central Display Settings

Both mirrors - both mirrors will dip when reverse is engaged.

Passenger side mirror - passenger's side mirror will dip when reverse is engaged.

To set the amount the mirrors will dip when reverse is selected:

1. Switch the ignition on.
2. Select **Both mirrors** or **Passenger side mirror** in the mirror dip section of the cluster.
3. Depress the brake pedal and select reverse gear.
4. Adjust mirror(s) to desired position, see *Adjusting mirrors*, page 1.47.
5. Take vehicle out of reverse.

The next time reverse is selected, the vehicle will automatically move the mirror(s) to the previously set offset from the normal position.

Camera guidelines

With camera guidelines set to **On**, coloured grid lines will be overlaid onto the live video feed as a guide to the proximity of visible objects to the rear bumper of the vehicle. Select **Off** to deactivate this feature.

Performance Shift Cue (PSC)

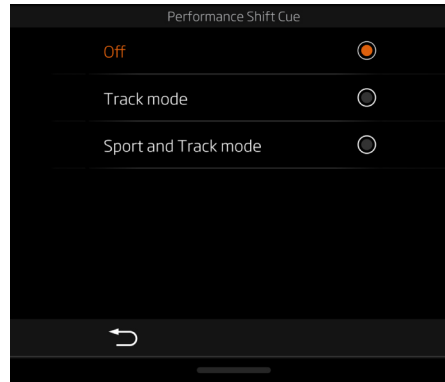

Performance Shift Cue (PSC) is an audible shift indicator, which will sound during full throttle acceleration in manual gearbox mode, to indicate that an upshift is required to maintain optimum performance.

When **Off** is selected, the PSC function will be disabled.

When **Track mode** is selected, PSC will only be active in Track powertrain or handling modes.

When **Sport and Track mode** is selected, PSC will be active in either Sport or Track powertrain or handling modes.

Auto alarm

When auto alarm is set to **On**, the vehicle will automatically lock and the alarm set if unlocked and left for 30 seconds with all doors, luggage compartment lid and service access panels left fully closed. Select **Off** to deactivate this feature.

Automatic door locking

When you receive the vehicle, automatic door locking will be set to **On**.

The vehicle doors will automatically lock as the vehicle moves off.

Select **Off** to deactivate this feature. The doors remain unlocked after moving off, unless they are locked manually.

Automatic mirror folding

When **On** is selected, the exterior mirrors will fold as the vehicle is locked and unfold when the door is opened. If **Off** is selected, the mirrors will remain in their driving position.

Central Display Settings

Door unlock

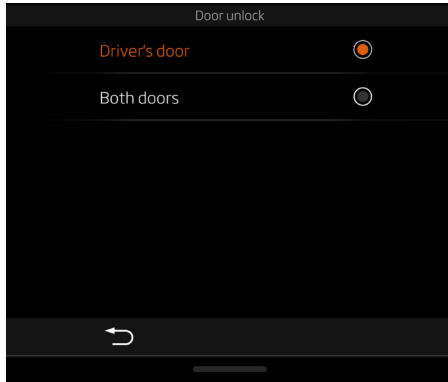

When **Driver's door** is selected, only the driver's door will unlock when the vehicle is unlocked with either the key fob or door button.

When **Both doors** is selected, both doors will unlock when the vehicle is unlocked using either the key fob or door button.

All closures will lock with either **Driver's door** or **Both doors** selected.

Silent door lock

When **On** is selected, the direction indicators are disabled when locking or unlocking using the keyless entry system.

If **Off** is selected, the direction indicators always flash when the vehicle is locked or unlocked, irrespective of the method used.

All other lock and unlock features remain active.

Tyre type

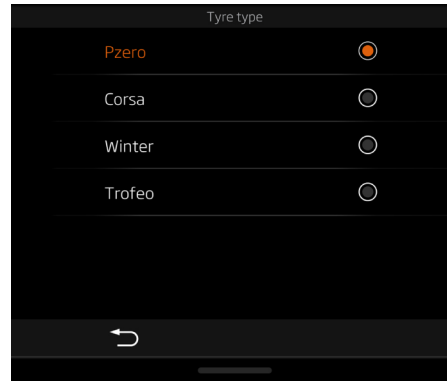

The display will show all the possible tyre types available. Select the tyres fitted to your vehicle.

Valet mode

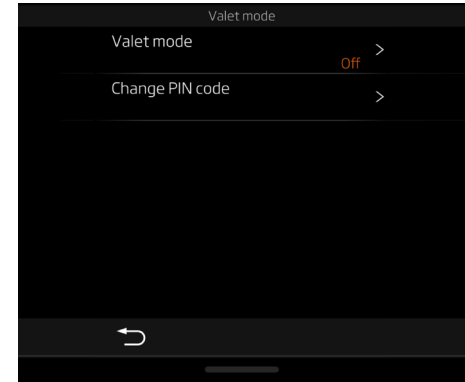

With valet mode on, the speed of the vehicle is limited to 35 mph (55 km/h), the Active Dynamics Panel is disabled, the luggage compartment, centre console stowage compartment (except 765LT) and service cover remain locked, and a confirmation message appears on the instrument cluster.

To switch on valet mode you must input a PIN code after selecting Valet mode.

Central Display Settings

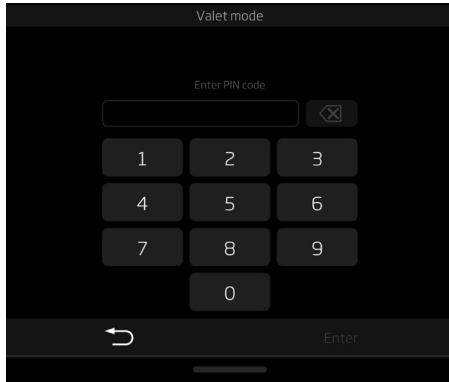

Enter the four digit PIN code using on-screen key pad, then touch **Enter** to confirm. An asterisk replaces each number as it is entered.

The factory set PIN code is 0000. Use this PIN code the first time to switch on valet mode. You should change this PIN code at the earliest opportunity.

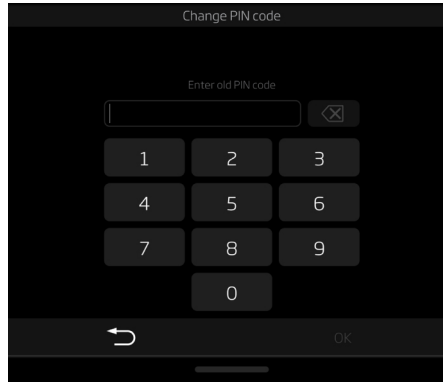

Select **Change PIN code**, then enter the old PIN code, followed by a new PIN code using on-screen key pad, then touch **Enter** to confirm.

When valet mode is **On**, enter the PIN code to switch valet mode off.

Wiper mode

Select either **Automatic** or **Timed**.

With **Automatic** selected, wiper operation in the auto position will be controlled by the rain sensor. To set the sensitivity of the rain sensor, see **Wiper sensitivity**, page 4.21.

With **Timed** selected, wiper operation in the auto position will be an intermittent wipe.

Wiper sensitivity

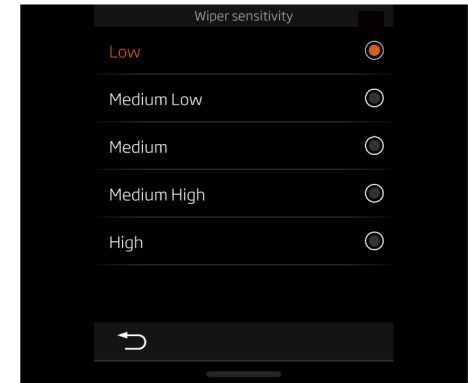

Select the sensitivity level to suit your preference for wiper operation. This setting will apply for the rain sensor sensitivity level only and will not affect the intermittent wipe time delay.

Speed limit display

When **On** is selected, the speed limit for the current road will be displayed on the Folding Driver Display if available.

Central Display Settings

Navigation

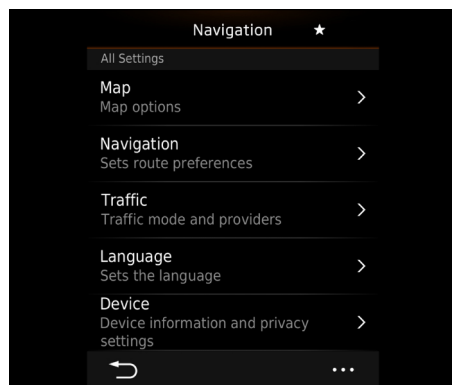

The following navigation settings are available:

- Map, page 4.22
- Navigation, page 4.23
- Traffic, page 4.23
- Language, page 4.23
- Device, page 4.23

Map

The following settings can be used to adjust the view and level of detail displayed on the map.

Driving Map View

Select **Track Up** to show a 2D view where the icon representing the vehicle will always travel up the screen and the orientation of the map will change when the car changes direction.

Select **North Up** to show a 2D view where North is always at the top of the screen. The icon which represents the vehicle will travel around the screen, according to the actual direction of travel: for example, downwards if travelling south.

Select **3D** to show a view where the map is shown in a 3D perspective view with the vehicle icon travelling up the screen. The orientation of the map will change as the car changes direction.

Select your preferred view, then touch **Save** to confirm or **Cancel** to return to the previous menu.

Map Detail

Select your preferred level of detail to be displayed on the map, then touch **Save** to confirm or **Cancel** to return to the previous menu.

Map Theme

Select your preferred map theme, then touch **Save** to confirm or **Cancel** to return to the previous menu.

Map Buttons

Select additional buttons to be shown on the map, then touch **Save** to confirm or **Cancel** to return to the previous menu.

Map Layers

Select additional layers to be shown on the map which may enhance the view with additional 3D features or Points of Interest (POI) along your route. Touch the option to toggle it on or off, then touch **Save** to confirm or **Cancel** to return to the previous menu.

Auto Zoom

The screen can zoom in or out automatically to predefined levels depending on vehicle speed. Touch the option to toggle it on or off.

Audible Speed Alerts

The McLaren Infotainment System (MIS) can provide an audible alert when approaching known fixed speed camera locations. Touch the option to toggle it on or off.

myMaps

This will show the details of the maps installed on the MIS.

Central Display Settings

Navigation

The navigation route can be calculated by prioritising a **Faster Time** or **Shorter Distance**. Touch your preferred option to select it, then touch **Save** to confirm or **Cancel** to return to the previous menu.

Select **Avoidances** to view the options available to avoid parts of the journey, such as motorways. Touch any options you wish to avoid to toggle it on or off, then touch **Save** to confirm or **Cancel** to return to the previous menu.

Select **Custom Avoidances** and follow the on-screen prompts to select a specific road or area of the map to avoid.

Touch **Voice Prompts** to enable the voice guidance of your planned route. Touch again to disable the feature.

Traffic

Touch **Traffic** to toggle the feature on or off.

Select **Subscriptions** to view and manage your current traffic subscription services.

The trafficTrends™ feature will collect and make use of historical traffic data to calculate more efficient routes. Different routes may be calculated for the same journey, depending on the day of the week or the time. Touch **trafficTrends™** to toggle this feature on or off.

Touch **Traffic Voice Prompts** to enable the MIS to announce any known traffic issues near your route. Touch again to disable the feature.

Language

Select your preferred navigation voice language and gender from the available options.



NOTE: Some voices may announce additional information, such as street names. Confirmation of this will be displayed beneath the voice name.

Device

Select **About** to view full details of maps currently installed on the MIS.

The myTrends™ feature monitors where you travel to regularly and once it has collected enough data, can predict where you are travelling to. This feature can offer useful information about your route, such as traffic conditions and offer alternative routes without the need to manually set the destination.

Touch **myTrends™** to toggle the feature on or off or **Delete myTrends™ History** to erase all collected data.

Central Display Settings

Cameras

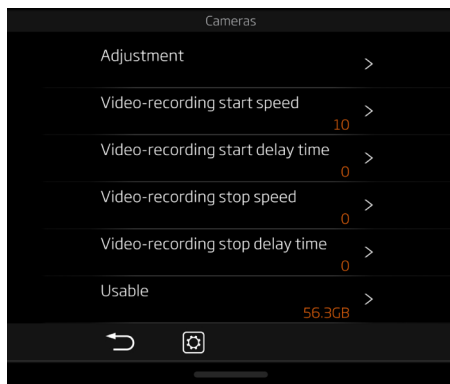

Select **Adjustment** to alter the video settings.
The following effects can be adjusted:

- Brightness
- Contrast
- Colour depth
- Tint
- Gamma

Video recording can be set to start and stop automatically. Adjust the video recording start speed, stop speed, start time delay and stop time delay as required.

Usable shows the amount of storage space available for recording video.

i NOTE: The storage space is shared by all features of the McLaren Infotainment System (MIS), including media.

Garage door opener settings

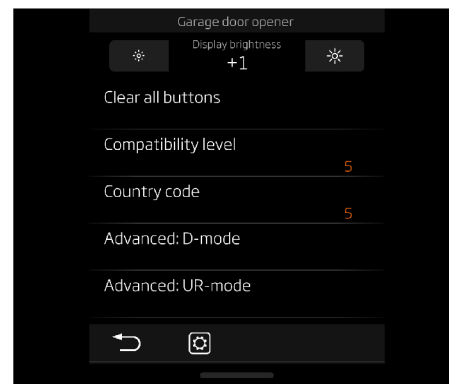

Central Display Phone

Overview



The McLaren Infotainment System (MIS) provides the facility to make and receive calls safely and hands-free, by connecting to your mobile phone using Bluetooth®.

The connection provides you with access to the contacts and call history stored on your phone.

The MIS can deal with conference calls, if supported by the connected phone, but cannot initiate them.



WARNING: Do not allow yourself to become distracted by the phone while driving. You could cause an accident.

Safety precautions



WARNING: Never attempt to operate the phone while the vehicle is moving. You could become distracted and cause an accident.



WARNING: Always store your phone securely. Unsecured objects can become dangerous missiles in the event of an accident.



WARNING: Always switch off the phone in areas with a high risk of explosion. These areas include filling stations, fuel storage areas or chemical factories, as well as places where the air contains fuel vapour, chemicals or metal dust. The operation of cardiac pacemakers or hearing aids may be impaired when the phone is in use. Check with your doctor or the manufacturer of the equipment to establish if anyone who is using such devices, is sufficiently protected against high frequency energy.

McLaren recommend that, to avoid potential interference, a minimum distance of 15 cm (6 in) is maintained between a wireless phone antenna and a cardiac pacemaker.

Bluetooth®

Bluetooth® is the short-range radio frequency (RF) technology which allows electronic devices to communicate with each other wirelessly.

Compatible Bluetooth® phones can be used in conjunction with the MIS.

The MIS system supports Bluetooth® Hands-Free Profile 1.6 (HFP 1.6). If the mobile phone connected to the system also supports this profile, features such as battery meter and signal strength may be displayed on the screen.

Your mobile phone must be paired and connected with the MIS before it can be operated, see Device pairing, page 4.26 and Connecting a phone, page 4.27.

Central Display Phone

Device pairing

1. By default, Bluetooth® will be switched on and the McLaren Infotainment System (MIS) will be in discoverable mode. If Bluetooth® is not on, switch on manually, see Connection settings, page 4.13.
2. Using your mobile phone, select the search for Bluetooth® devices function.



NOTE: On some phones, this is referred to as a new paired device. Refer to your phone's operating instructions for the exact description.

3. Select "MIS" from the list of available devices.
4. The MIS will display a passkey.

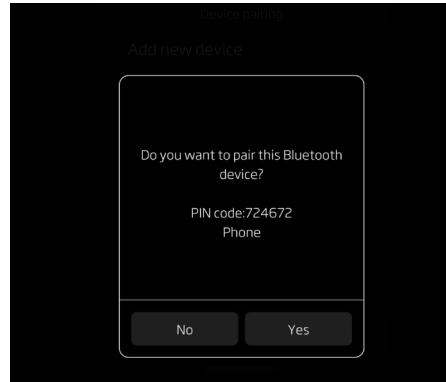

5. Select **Yes** to confirm that the passkey displayed on the MIS is the same as the passkey displayed on your phone.
6. Select **Pair** on your phone.

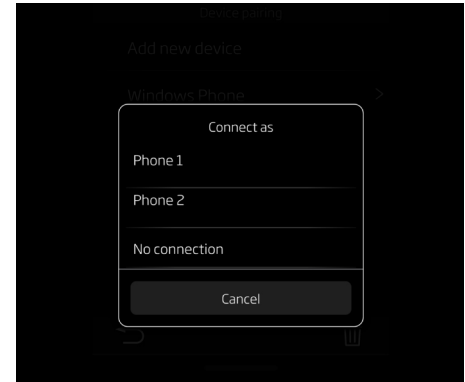

7. Once your phone has paired and connected to the MIS, select whether to connect as **Phone 1** or **Phone 2**. Select **No connection** if the Bluetooth® device is to be used for audio streaming only.

Central Display Phone

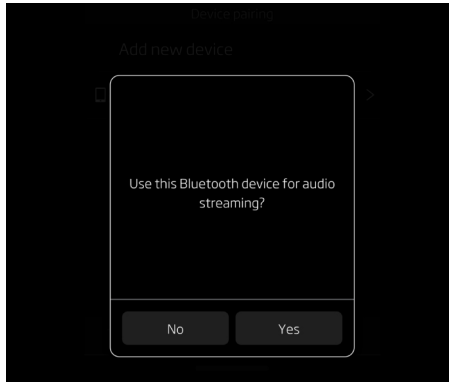

8. If supported by your phone, the MIS will ask if you wish to use your phone for Bluetooth® audio streaming, select Yes to enable this feature.
9. While pairing some devices which support internet connection sharing via Bluetooth®, you may have to choose which Access Point Name (APN) your device will use to access the internet.
Select the option appropriate to your device and contract.
Internet sharing via Bluetooth® can be disabled using the settings on your phone.

10. Once your phone has been paired and connected to the MIS, it will connect automatically whenever it comes within range.
11. If it does not automatically connect, it will be necessary to connect manually to the MIS, using the mobile phone controls.

i NOTE: Some phones must be manually connected.
Some phones require the connection to be authorised each time. Set MIS as authorised in the phone's known device list, to prevent this.

See Bluetooth phone settings, page 4.16 for detail of all options available.

Pairing additional devices

The procedure for connecting additional devices is the same as when pairing the first phone, see Device pairing, page 4.26.

A maximum of 12 devices can be paired with the MIS, but only two can be connected at a time.

i NOTE: If the maximum number of devices are already connected to the MIS, an additional device can be paired, but will not be connected. The original devices will remain connected to the MIS.

Connecting a phone

If you have already paired a phone, the MIS will automatically reconnect to it when the phone comes within range unless other devices are connected.

i NOTE: Some phones must be manually connected.
Some phones require the connection to be authorised each time. Set MIS as authorised in the phone's known device list, to prevent this.

Your phone will be disconnected when the MIS or the vehicle is switched off. Automatic reconnection may take several seconds when the vehicle or the MIS is switched on again.

Central Display Phone

Making a call

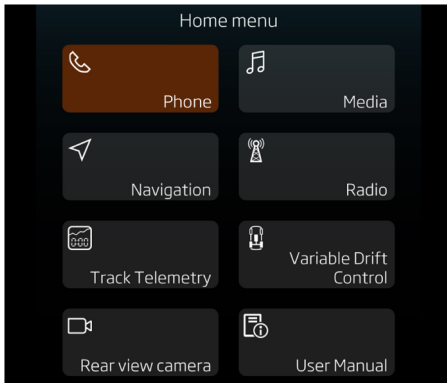

There are a number of ways of making a call, these are explained in the following pages.

To switch to the phone application, touch the Phone icon from the McLaren Infotainment System (MIS) Home screen or press the Phone button.

Using the keypad

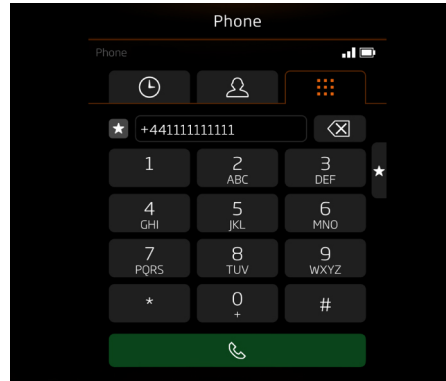

1. From the Phone screen, touch the keypad tab.
2. Phone numbers can be entered using the on-screen keypad.

If you enter an incorrect number or digit, touch the  icon to delete the last digit.

3. Touch the  icon when the complete number is displayed on the screen to begin the call.

4. A call can be cancelled, while the system is dialling, by touching the  icon or phone button.

 **NOTE:** Any media or radio play will be muted while a call is in progress.

Using contacts

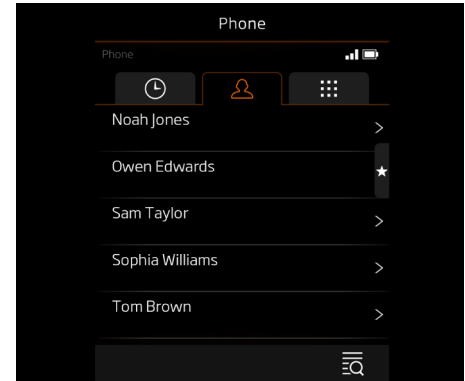

1. From the Phone screen, touch the contact tab.
2. Once your contacts are displayed, a specific person can be found by scrolling through the list.

Central Display Phone

3. Select a contact to view all available phone numbers for that contact. Touch the required number to begin the call.
4. A call can be cancelled, while the system is dialling, by touching the  icon or phone button.

 **NOTE:** Any media or radio play will be muted while a call is in progress.

Using call history

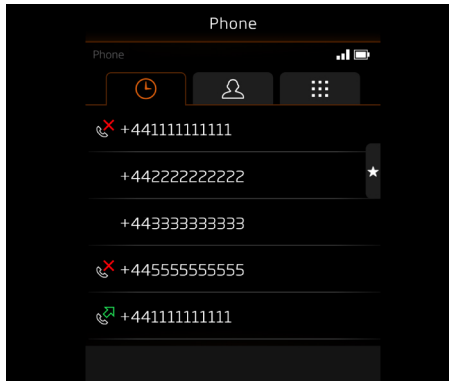



1. From the Phone screen, touch the call history tab.

2. A list of dialled, missed and received calls will be displayed in chronological order with most recent on top.
3. Touch the required contact to begin the call.
4. A call can be cancelled, while the system is dialling, by touching the  icon or phone button.

 **NOTE:** Any media or radio play will be muted while a call is in progress.

Favourites

1. Press the  icon to display a list of your favourite contacts.

 **NOTE:** The contacts must be tagged as favourite by selecting  before they will appear in this list.

Receiving a call

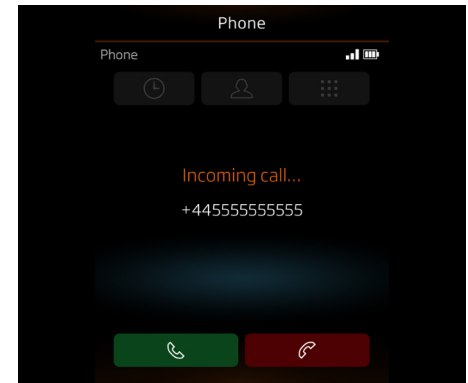

When you receive an incoming call, the McLaren Infotainment System (MIS) will display any caller details which are stored on your phone and synchronised with the MIS.

To accept the call, touch the green  icon.

 **NOTE:** The MIS can automatically answer an incoming call, see Bluetooth phone settings, page 4.16.

To decline the call, touch the red  icon.

Central Display Phone

In-call options

 Touch the mute icon to disable the microphone, touch again to enable it.

 Touch the keypad icon to launch the on-screen keypad, touch again to hide it.

 Touch the switch to phone icon to transfer the call to your phone handset, touch switch to speakers to transfer back.

Ending a call

 To end a call from the call in progress screen, touch the red end call icon.

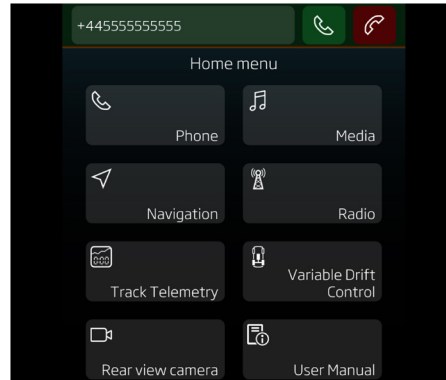

 To end a call while viewing a different system screen, touch the red end call icon adjacent to the call in progress display at the top of the screen.

Contacts

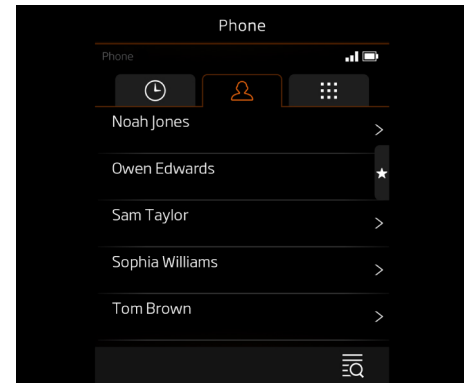

1. From the Phone screen, touch the contact tab.

-  **NOTE:** Dependent on phone model, pictures of contacts stored on your phone, will be displayed on the screen alongside the contact name.
2. If your contact list extends beyond the depth of a single screen, scroll up and down the list by swiping your finger upwards or downwards on the screen.

Central Display Phone



i NOTE: Contacts can be sorted by either first name or last name, see Bluetooth phone settings, page 4.16 for more information.

3. Alternatively, you can search for a contact using the on-screen keyboard, see Search, page 4.31.
4. Select a contact to view all available phone numbers for that contact. Touch the required number to begin the call.

i NOTE: Dependent on phone model, if pictures of contacts are stored on your phone, these will be displayed on the screen during a call if contacts have been synchronised with the MIS.

5. A call can be cancelled, while the system is dialling, by touching the  icon or phone button.

i NOTE: Any media or radio play will be muted while a call is in progress.

i NOTE: To tag a contact as a favourite touch .
Touch  again to remove them from your favourites.

Search

1. Press the  icon from the contacts tab.
2. Using the on-screen keyboard, enter at least one character to filter the displayed contacts.

If you enter an incorrect number or digit, touch the  icon to delete the last digit.

i NOTE: Contacts can be sorted by either first name or last name, see Bluetooth phone settings, page 4.16 for more information.

3. Select a contact to view all available phone numbers for that contact. Touch the required number to begin the call.

i NOTE: Dependent on phone model, if pictures of contacts are stored on your phone, these will be displayed on the screen during a call if contacts have been synchronised with the MIS.

4. A call can be cancelled, while the system is dialling, by touching the  icon or phone button.

i NOTE: Any media or radio play will be muted while a call is in progress.

Central Display Media

Overview

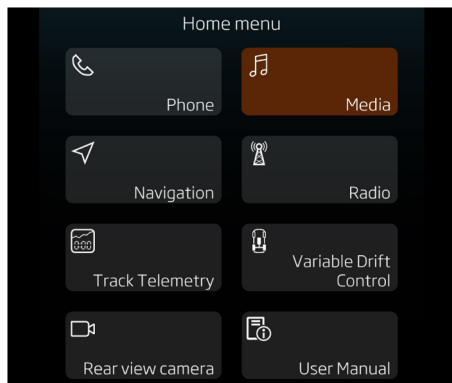

The functions of the media player can be accessed by touching the Media icon from the McLaren Infotainment System (MIS) Home screen or press the Media button.

Selecting Media will present the available audio sources.

Audio sources

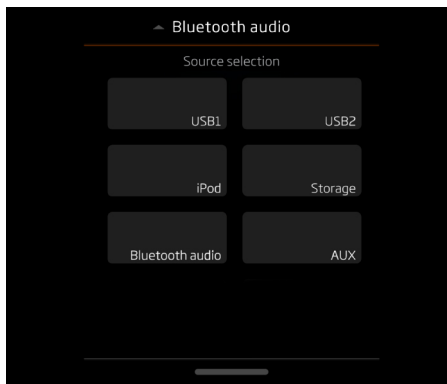

If music devices are connected to the USB port, the auxiliary socket and Bluetooth®, all sources will appear on the screen, with their respective symbols at the top of the screen.

i NOTE: If a device is not available, it will be greyed out in the list.

Supported media devices

For a list of current compatible media devices, please contact your McLaren Retailer.

Supported media files

The media system can play files of the following format/encoding combinations.

Audio:

- MP3
- AAC
- WMA
- OGG Vorbis
- AC3
- AMR
- FLAC
- WAV
- AIFF

Video:

- MPEG1
- MPEG2
- H.264/MPEG-4 AVC
- MPEG-4 Video
- DivX 4/5
- XviD HT
- VC-1

Central Display Media

Media controls

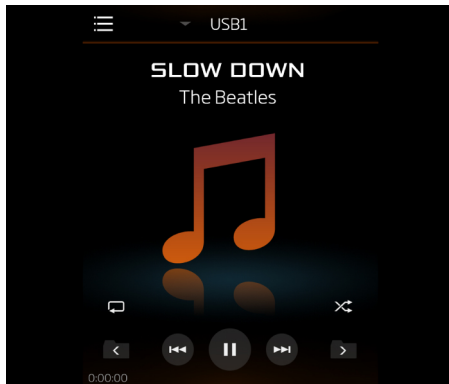

Music played from the internal storage or connected device can be controlled using the McLaren Infotainment System (MIS) touch screen.

Once music has started playing, the artist's name, the album title and the song title will appear on the screen. If there is any artwork associated with the song, that will also be displayed, if no artwork is available, a representation of a musical note will be shown.

Move forward or backward through the current track by touching and holding the or icons. Alternatively, you can touch and drag the progress bar to move through the track.

A single touch of will skip to the next track. A single touch of icons will skip to the start of the current track, a second touch will skip to the previous track.

Swipe gestures can also be used to skip tracks. Swipe the screen from left to right in order to skip to the next track. Swipe the screen from right to left in order to skip to the start of a track, swipe again to skip to the previous track.

Touch the or icon to skip to the next or previous folder.

To pause a track, touch the icon. To resume play, touch the icon. A track can also be paused or played by tapping the screen.

To randomly play through the current selection, press the icon. The icon will turn amber when random is active.

NOTE: This function is not available for Bluetooth® devices.

To activate the repeat feature, press the icon. The icon will turn amber when repeat is active.

NOTE: This function is not available for Bluetooth® devices.

Touch the icon to browse for another track, playlist or folder.

NOTE: This function is not available for Bluetooth® devices.

Central Display Media

Connecting an external device



Open the centre console and connect the device as required.

Ensure that the centre console is closed before driving.

1. USB1 or iPod
2. USB2
3. 3.5 mm auxiliary line in

See Device pairing, page 4.26 for details on connecting a Bluetooth® device.

- i** NOTE: Any internal batteries fitted to your device will be charged through either USB port.
- i** NOTE: The USB1 port has a high power output suitable for charging mobile devices.

USB and iPod

Connect a USB device, see Connecting an external device, page 4.34.

From the Media screen, select USB1, USB2 or iPod.

- i** NOTE: Any internal batteries fitted to your device will be charged through the USB port.
- i** NOTE: The USB1 port has a high power output suitable for charging mobile devices.

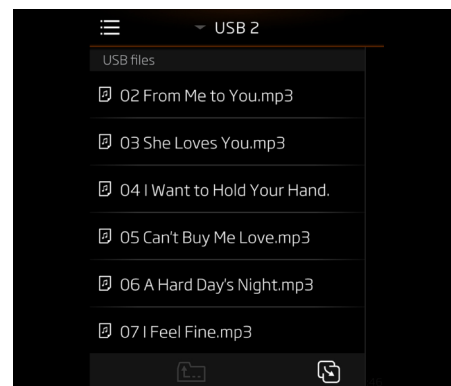

Central Display Media

Browse to the folder or playlist you wish to listen to, select a track to begin playing.

If multiple folders exist, touch the  to navigate up the folder levels.

Copy to storage

Browse to the files you wish to copy and touch the  icon.

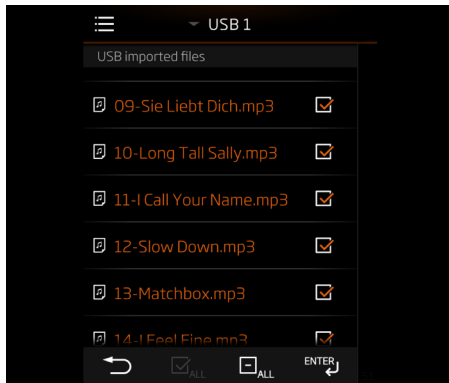

Select the files to be copied, then touch the  to confirm the selection. Once a destination folder has been selected, the McLaren Infotainment System (MIS) will display the progress while files are copied.

Storage

From the Media screen, select Storage.

Browse to the folder or playlist you wish to listen to, select a track to begin playing.

Manage files

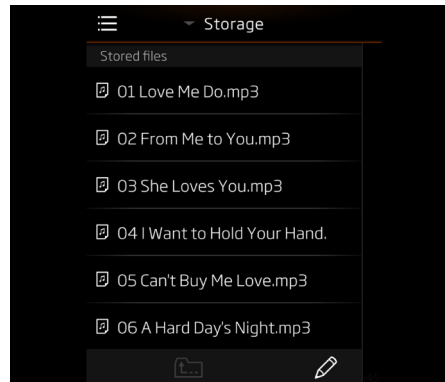

Touch the  icon in to access the Manage files menu. Use this menu in order to create folders, or move or delete selected files stored on the McLaren Infotainment System (MIS).

Import files

Files can be imported from a connected USB device. See Copy to storage, page 4.35.

Erase storage

Select  to access the storage settings. Select Storage erased in order to remove all media imported onto the MIS.

Central Display Media

Bluetooth audio

Connect a Bluetooth® device, see Device pairing, page 4.26.

From the Media screen, select the Bluetooth audio source.

Music may begin playing automatically, depending on the Bluetooth® device connected. If music does not start playing automatically, select play on the device itself.

The Bluetooth® symbol  will appear at the top of the screen while music is playing.

The volume can be adjusted using the McLaren Infotainment System (MIS), see System controls, page 4.04.

Audio volume is dependent on the output volume of the device attached, and the MIS volume.

AUX

Connect a device to the auxiliary socket, see Connecting an external device, page 4.34.

From the Media screen, select the AUX audio source.

Play from any device connected through the auxiliary socket must be controlled from the device itself.

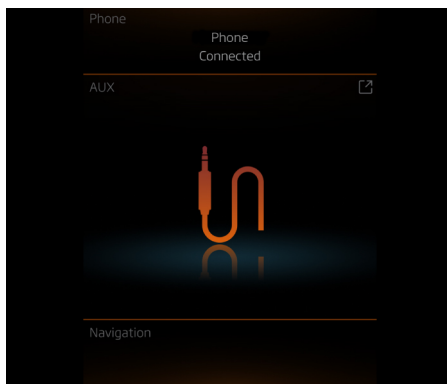

The screen will show a graphic representing a jack plug, when media is played from a device connected to the auxiliary socket.

 **NOTE:** Any internal battery fitted to the device will not be charged by the auxiliary socket while it is connected.

The volume can be adjusted using the McLaren Infotainment System (MIS), see System controls, page 4.04.

Audio volume is dependent on the output volume of the device attached, and the MIS volume.

 **NOTE:** If a static or hiss sound is heard, adjust the volume of the device and/or MIS to compensate.

Central Display Navigation

Overview



The navigation system uses signals from Global Positioning System (GPS) satellites together with information from vehicle sensors and map data stored on the McLaren Infotainment System (MIS) to determine the precise location of the vehicle.

Using this data, the system is able to create the optimum route to your destination, taking into account any journey preferences you may have set.

To set your preferences, see Navigation, page 4.22.

Creation of a specific route is achieved by using the on-screen menus and the MIS controls, to make your selections. This results in your route being highlighted on the map.

Once you have started a journey, turn information is displayed on the Central Infotainment Touchscreen, supplemented by voice guidance if required, at appropriate points during the journey.

When a significant diversion is made from a planned route, the system will automatically recalculate an alternative route to the destination.

Safety



WARNING: For your safety, ensure that you do not become distracted from the task of driving, through use of the navigation system. Read and adhere to the safety message which appears the first time you enter the navigation system after switching on the ignition.

National road traffic laws and traffic signals must always be obeyed.

Always remember that the purpose of the navigation system is to help in determining the optimum route, it must never be considered as an aid when visibility is reduced.

GPS signals may be interrupted when travelling through tunnels or other situations where GPS signal could be blocked. Navigation will continue on the route until GPS signal is regained.



The GPS signal strength is indicated by the icon in the status bar.

Errors in vehicle position are also possible under the conditions described, and if any of the following have occurred:

- driving inside a building e.g. a multi-storey car park
- travelling on a road with a second parallel road very close
- a turntable has been used to rotate the vehicle
- the vehicle has been transported to a different location

Central Display Navigation

Using Navigation

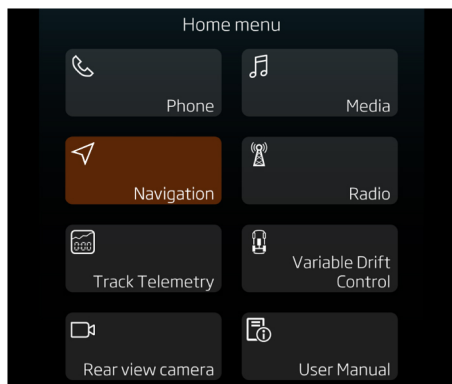

Touch the Navigation icon from the McLaren Infotainment System (MIS) Home screen or press the Navigation button.

The first time you access navigation after the ignition is switched on, the MIS displays safety warning messages. Please read these messages.

The caution message will automatically disappear once the navigation system has finished loading.

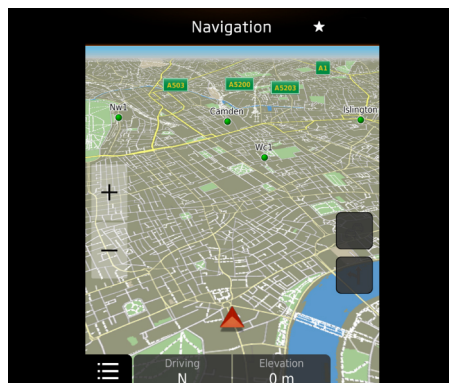

A map showing your current location will appear on the Central Infotainment Touchscreen screen.

 The location and direction of travel of your car is shown as an arrow head on the screen.

To manipulate the area of the map which is displayed, touch the screen and gently move your finger in any direction to move around the map.

To setup the navigation system to your preference, see Navigation, page 4.22.

 Touch the icon from the map screen in order access the options for setting a destination, see Setting a destination, page 4.39.

The MIS has a multi-touch screen, allowing easy zooming in and out using pinch gestures. Touch the screen with thumb and forefinger and move them closer together to zoom out, move them further apart in order to zoom in again.

The + and - icons can also be used to zoom in and out.

Details on the screen will change depending on the zoom setting. For example, road names and some Points of Interest (POIs) will be shown when zoomed in close, but not when zoomed further out.

The screen will also zoom in or out automatically to predefined levels depending on vehicle speed. This function can be turned on or off in the settings menu. See Navigation, page 4.22 for more details.

The screen colour will automatically change between day and night mode for easier viewing based on the time.

Central Display Navigation

Setting a destination

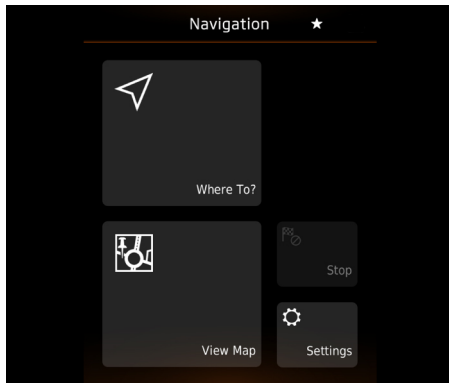

Select **Where To?** to use the menus to find and select a destination.

Select **View Map** to use the screen interactively to find and select a destination from the map.

Select **Settings** view or adjust any navigation preferences. See Navigation, page 4.22.

Select **Stop** to end the current route guidance.

Using the menus

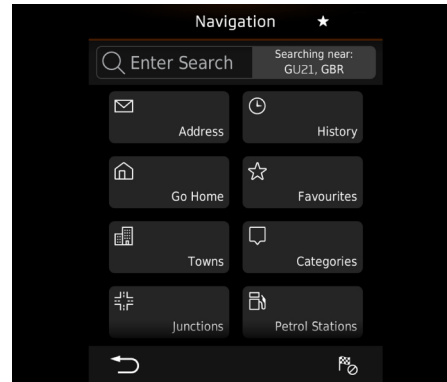

The following options are available:

Search

Use the search feature to find a destination using the name, address or postcode of a location.

History

Select a destination from a list of previous locations.

Go Home

Select **Go Home** to navigate directly to your home address.

i NOTE: If you have not already saved your home address, you can follow the on-screen prompts to do so before navigation begins.

Favourites

Select a destination from your saved favourite locations. Addresses and locations can be saved as favourites by selecting the  icon.

Towns

Select **Towns** to set a destination within a specific town or city.

Categories

Select a destination from the Points of Interest (POI) within the available categories.

Junctions

Select a junction on specific road.

Petrol Stations

Select a petrol station in your area or along your route.

Central Display

Navigation

Coordinates

Enter latitude and longitude coordinates to set a specific destination.

Trip Planner

Use the **Trip Planner** to plan a route. Use the available options to set a start location, end location and any specific waypoints you wish to pass through or stop at along your route.

Using the screen

Manually move around the map, until the map is displayed at the most effective scale for locating the general area of your destination.

Touch the map to mark the position of your desired destination.

Route Overview

Once your destination has been selected, an overview will be displayed, with your route highlighted. Your start position, current position, any waypoint(s) and your destination will be shown along the highlighted route.

Select  to save the destination as a favourite or **Go!** to begin navigation.

Central Display Radio

Overview

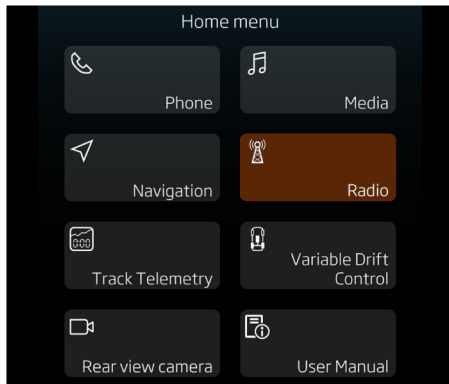

When Radio is selected from the McLaren Infotainment System (MIS) Home screen, or using the Radio button, the radio will launch and tune to the previously selected station.

Wavebands

The radio can receive and tune AM, FM and DAB stations.

The waveband currently selected is displayed at the top of the screen.



 To change the waveband, briefly touch the icon. AM, FM or DAB will be displayed at the top of the screen to indicate the change in the selected waveband.

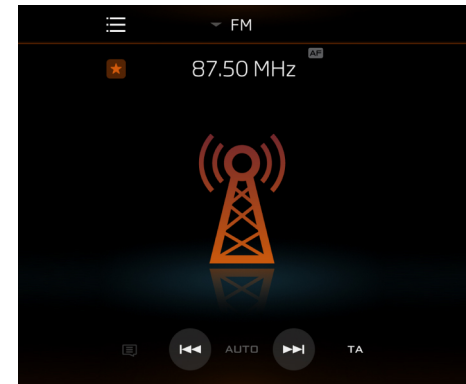

Radio controls



A station can be selected by either manually tuning or selecting a favourite. The frequency will be displayed on the screen along with the station name if available.

 **NOTE:** If the station frequency changes, the favourite preset will have to be set again.

To automatically tune to the previous or next available station, touching the  or  icons.

When tuning manually, touch the  or  icon to incrementally move through the frequency.

Central Display Radio

Swipe gestures can also be used to tune the radio in both manual and auto tuning modes.

Touch the  icon to save a station as a favourite.

Radio data system (RDS)

RDS is a system which allows digital data to be sent to radio receivers at the same time as the FM signal.

Two types of digital data can be received and their status shown on the screen: Alternative Frequencies and Traffic Alerts.

Alternative frequencies (AF)

The AF feature automatically selects the strongest signal for radio reception.

As your vehicle moves away from one transmitter and nearer to another, AF will switch transmitters to maintain the best reception possible.

AF can be toggled **On** or **Off** in the Settings menu, see Radio & media settings, page 4.15.

Traffic alert (TA)

Traffic alerts interrupt radio and media playback to inform the driver of traffic conditions.

TA can be toggled **On** or **Off** in the Settings menu, see Radio & media settings, page 4.15.

Central Display McLaren Track Telemetry

Overview

WARNING: For your safety, ensure that you do not become distracted from the task of driving, through use of any of these systems.

WARNING: McLaren Track Telemetry is intended for track use only. The driver is responsible for safety and compliance at all times.

McLaren Track Telemetry provides timing data recording and graphical visualisation for track use, e.g. circuits and hill-climbs.

During a recording, graphical displays are provided for timing data, performance delta, track maps and vehicle speed.

Track performance can be analysed in a data viewer, and navigated via the lap number, track position or track distance.

Custom track maps are created automatically and can be manually edited. Multiple track layouts or configurations are supported for each venue.

Different drivers can be associated with each recording.

Opening the application

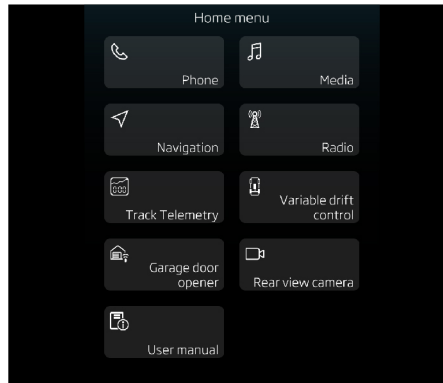

1. Select Track Telemetry from the Home menu, or scroll to the McLaren Track Telemetry application in the Central Infotainment Touchscreen carousel.

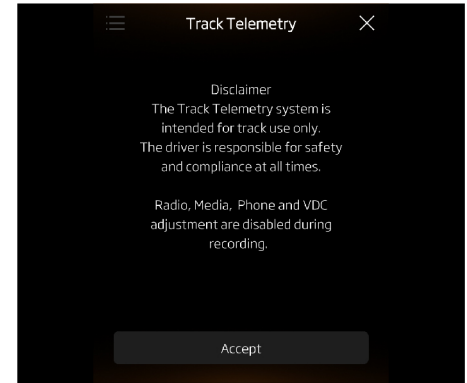

2. Read and accept the disclaimer.

McLaren Track Telemetry is intended for track use only. The driver is responsible for safety and compliance at all times.

NOTE: When McLaren Track Telemetry is in use, other applications will not be available (including Navigation, Media, Phone, Radio and Variable Drift Control).

Central Display

McLaren Track Telemetry

Setup

Open McLaren Track Telemetry and define your session:

- Driver's name
- Weather
- Track name
- Compare with
- Number of laps

Before you start your session, adjust the camera layout for the video recording by pressing 

If the required track has not yet been saved, it will need to be created in the system. Press Add new track and follow the on-screen instructions.

 **NOTE:** It is possible to record both a closed circuit and a hill-climb.

If the required track has been saved, the session can be started immediately by pressing Start and driving onto the track.

Drive

Once your session is underway, you can see your key data on both the Folding Driver Display and the Central Infotainment Touchscreen.

With the Folding Driver Display in Full Display Mode, use the left stalk to change the content of the display.

Lap times (current, previous, reference)



Top speed (Real speed, Max speed, etc.)



Central Display McLaren Track Telemetry

Track map (2D/3D view of the track ahead)



Table of lap times

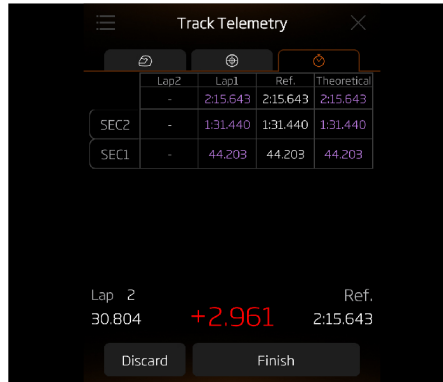

G-Map and pedal position

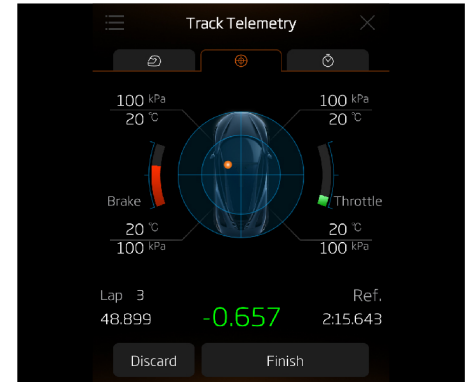

With the Folding Driver Display in Slim Display Mode, timing splits and delta will be displayed at the completion of each sector and lap.

On the Central Infotainment Touchscreen, use the tabs to change view between:

Central Display McLaren Track Telemetry

Graphing of a chosen data feed

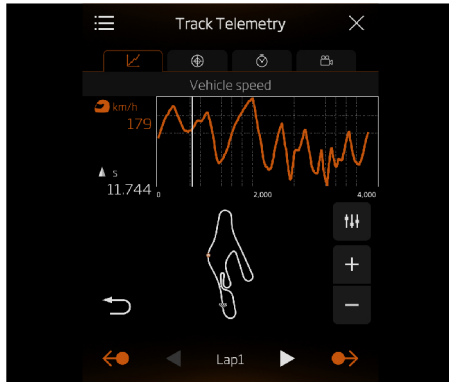

Ending your session

Press Finish to end your session.

Reviewing your data

- i** NOTE: McLaren Track Telemetry has some powerful analysis tools. For more powerful and flexible tools, use the off-board application (available for Mac, PC and iPad).
- i** NOTE: To download the off-board application, please refer to: <http://cars.mclaren.com/ownership/track-telemetry>

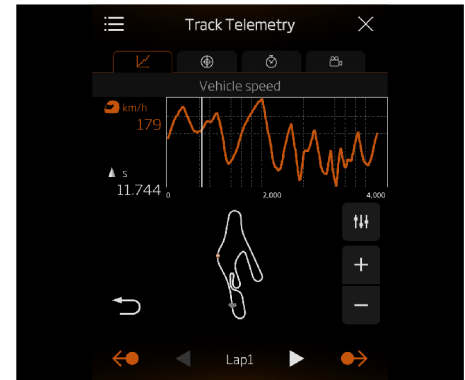

To open a session for analysis:



1. Press  to open the analysis.

Central Display

McLaren Track Telemetry



2. Choose a track and a session.
3. Use the tabs and controls to review your data and video footage.

To navigate within a session:

1. To choose a specific lap, press on the lap number and select a new one.
2. To scroll within a lap, press on the relevant part of the track or press  or  to move forwards or backwards through the lap.



Importing telemetry data

 NOTE: Tracks and sessions can be shared across vehicles.

1. Insert a USB storage device into one of the vehicle USB ports.
2. Press  to open the analysis.
3. Press  to import data from the USB storage device.

Exporting telemetry data

 NOTE: Tracks and sessions can be shared across vehicles.

1. Insert a USB storage device into one of the vehicle USB ports.
2. Press  to open the analysis.
3. Select the session to export and press .

Central Display

McLaren Track Telemetry

Editing a track

Stored tracks can be edited using the Central Infotainment Touchscreen, press  and select the required track.



The following items are editable:

- Track name
- Start/finish position
- Track direction
- Sectors (number and position)

Central Display



Garage Door Opener

Overview

-  **WARNING:** Do not use HomeLink® with any garage door opener that lacks the safety stop and reverse feature.
-  **WARNING:** Do not use HomeLink with any garage door opener that was manufactured before April 1982.
-  **WARNING:** When programming HomeLink to a garage door opener or entry gate, make sure that the area is clear of people and objects. **Damage or injury may occur, as the gate or garage door activates during programming.**

The HomeLink® wireless control system replaces up to three remote controls. HomeLink can be used to activate devices such as gate operators, garage door openers, entry door locks, security systems, and home lighting.

Programming

-  **WARNING:** When programming a garage door opener or gate operator, it is advised to unplug the device during the programming process. This prevents possible damage to the garage door opener or gate operator from repeat operation.
-  **NOTE:** Please note that the instructions below apply to the majority of HomeLink compatible devices. Some HomeLink applications or HomeLink compatible systems require slightly different instructions, for information on compatible devices and instructional videos, visit: www.homelink.com.
-  **NOTE:** Garage door openers manufactured after 1995 could be equipped with rolling code protection. In this case, refer to the manufacturer's instructions.

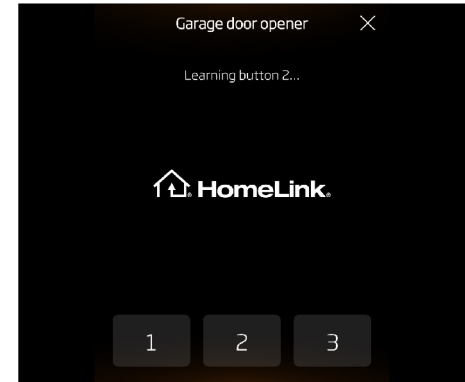

1. Press the HomeLink button that you would like to program, 'Learning button 1, 2 or 3' will be displayed on the Central Infotainment Touchscreen.
2. Position the garage door opener remote control 2–8 cm away from the left-hand headlamp.

Central Display Garage Door Opener

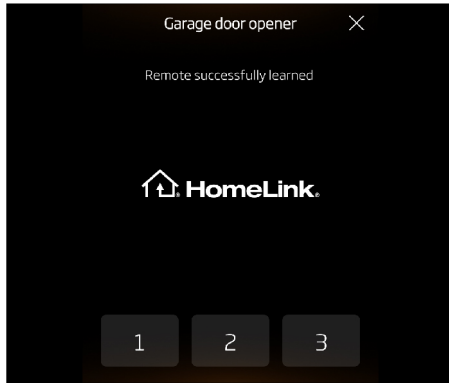

3. Press and hold the button on the garage door opener remote control, 'Remote successfully learned' will be displayed on the Central Infotainment Touchscreen and the exterior lights will flash. Release the garage door opener remote control button.



NOTE: Some remote device systems require the operator to press and release the garage door opener remote control button every 2-10 seconds during programming.

4. Press the programmed HomeLink button, if the device activates, programming is complete, if the device does not activate, continue with steps 5 to 7.
5. Locate the learn or smart button on the motor-head unit, located on the garage door opener's receiver. Refer to the garage door opener manual to identify the learn or smart button.
6. Press and release the learn or smart button. There are typically 30 seconds to initiate Step 7.
7. Return to the vehicle. Press and release the programmed HomeLink button every 2 seconds up to five separate times to activate the device. If the device activates, programming is complete.

Erasing all programmed garage door openers

To erase all previously programmed garage door openers:

1. From the garage door opener screen press  to display the Settings menu.
2. Press 'clear all buttons'.
3. Previous settings of all three buttons have now been erased.

HomeLink® and the HomeLink® house icon are registered trademarks of Gentex Corporation.

Central Display Voice Recognition

Overview



A mobile phone must be paired and connected with the MIS before the voice recognition feature can be used, see Device pairing, page 4.26 and Connecting a phone, page 4.27.

Press the button on the end of the left hand control stalk to activate the voice recognition function of a connected device.

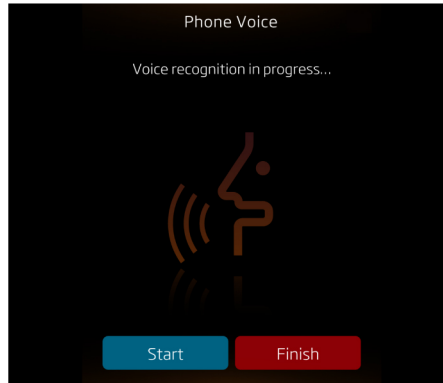

i NOTE: The level of functionality provided by the voice recognition feature will depend on the device connected via Bluetooth®.

McLaren 

Comfort and Convenience

Windows.....	5.02
Safety.....	5.02
Opening and closing.....	5.02
Climate Control.....	5.04
Overview.....	5.04
Controls.....	5.04
Modes of operation.....	5.05
A/C (screen) button.....	5.06
Demisting/Defrosting.....	5.07
Temperature control.....	5.07
Air recirculation mode.....	5.08
Blower speed control.....	5.09
Air distribution settings.....	5.09
Heated seats.....	5.10
Heated rear window.....	5.11
Interior Features.....	5.12
Interior lighting.....	5.12
Entry lighting.....	5.13
Exit lighting.....	5.13
Electrochromic Roof.....	5.13
Stowage compartments.....	5.14
Cup holders.....	5.16
Owner documentation.....	5.17
Sun visors.....	5.17
Accessory power sockets.....	5.17
USB sockets.....	5.18

Comfort and Convenience Windows

Safety

⚠ WARNING: Ensure that no one can be trapped as you open or close the windows. Do not rest any part of your body against the window. There is a risk of becoming trapped by the movement of the window. If there is a risk of entrapment, stop movement of the window.

Opening and closing

⚠ WARNING: The key fob allows the engine to be started and is also used to activate other features on the vehicle. **Take the key fob with you, every time you leave the vehicle to prevent unsupervised operation of the windows, which may result in injury.**

Switches for both windows are located on the driver's door console. A switch for the passenger's window is located on the passenger's door console.



1. Driver's window switch.
2. Passenger's window switch.

Press switch (1) or (2). The window will open for as long as the switch is pressed.

Pull switch (1) or (2). The window will close for as long as the switch is pressed.

To open or close a window fully, press or pull switch (1) or (2) fully and release.

i NOTE: To stop a window opening or closing, press or pull the appropriate switch.

i NOTE: If the vehicle is in awake mode, window control will not be available.

Resetting the windows

The windows must be reset if the battery has been discharged or disconnected, or if the anti-trap feature has been activated.

Ensure that both doors are closed and the ignition is switched on.

Comfort and Convenience Windows



Push switches (1) and (2) downwards until the windows are open and hold them in this position for 5 seconds.

Pull both switches upwards until the windows are closed and hold them in this position for 5 seconds.

The windows are now reset.

If this does not resolve the issue, please contact your McLaren retailer immediately.

Anti-trap protection

 **WARNING: Do not leave children unattended in the vehicle, they could be injured by the movement of the window.**

Anti-trap protection will stop windows closing if an obstruction or resistance is detected.

If the anti-trap protection is triggered, check the window and the window aperture and remove any obstruction, before operating the windows again. In the event of an anti-trap event when closing the door, see Closing a door, page 1.10.

Comfort and Convenience

Climate Control

Overview

The system can be operated in automatic mode or settings can be adjusted manually.

The combination filter reduces the quantity of dust and pollutants entering the vehicle.

⚠ WARNING: Follow the recommended settings given for heating or cooling. If the windows mist up, you may no longer be able to observe road and traffic conditions and could cause an accident.

i NOTE: The climate control system operates more effectively with the doors and windows closed. However, if the vehicle has been standing in a hot environment for a long time, ventilate by opening the windows briefly.

i NOTE: The interior air temperature sensor is located between the steering wheel and the centre console. Do not obstruct airflow to this sensor or the performance of the climate control system will be reduced.

i NOTE: The vehicle will retain the current climate control settings when the ignition is switched off.

Controls



The climate control system is operated using the Central Infotainment Touchscreen. Press the button to switch on the climate control screen.

Climate Controls

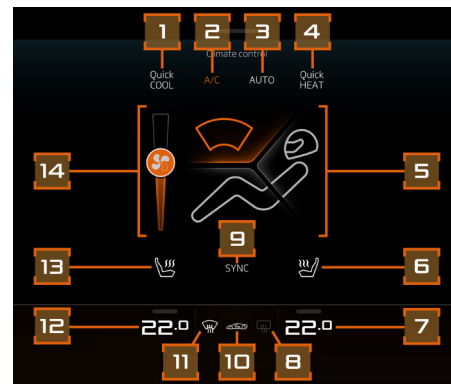

1. Quick COOL button
2. Air conditioning (A/C) button
3. AUTO button
4. Quick HEAT button
5. Air distribution buttons
6. Heated seat button - Right-hand side
7. Temperature control - Right-hand side
8. Heated rear window/mirrors
9. SYNC button
10. Air recirculation button
11. Air recirculation button
12. Temperature control - Left-hand side
13. Heated seat button - Left-hand side
14. Air distribution buttons

Comfort and Convenience

Climate Control

11. Demist button
12. Temperature control - Left-hand side
13. Heated seat button - Left-hand side
14. Blower speed control

i NOTE: Some features and icons on the McLaren Infotainment System (MIS) may be present but not functional, based on the options selected for your unique vehicle.

Modes of operation

Automatic Mode

In automatic mode, the climate control system maintains the set interior temperature using a combination of differing blower speeds, air recirculation and air distribution.

The control panel uses different colours to indicate operational states:

- Amber indicates ON.
- White indicates OFF but available for use.
- Grey indicates not available for use.

To switch on automatic mode, touch the AUTO button.

The button illuminates and the air distribution, temperature and blower speed are adjusted automatically on both sides of the vehicle.

In AUTO mode, there is no need to adjust the blower speed or air distribution, the system will operate whichever controls it needs to maintain the set temperature.

If you do wish to change the air distribution of the climate control system, touch the preferred button. This will then put the system into AUTO fan mode.

This is denoted by the colour of the blower speed slider. The bar is grey and the slider moves by itself when the blower is under automatic control. Here, the system is continuing to control the blower speed to maintain the set temperature.

If the blower speed is adjusted while AUTO is active, manual mode will be selected by default. If the AUTO button is then pressed, AUTO mode will be activated again.

If necessary, the system settings can be manually adjusted, see Manual Mode, page 5.05.

Manual Mode

To adjust the air temperature, see Temperature control, page 5.07.

To adjust the blower speed manually, see Blower speed control, page 5.09.

SYNC Mode

SYNC mode allows any changes the driver makes to their air temperature settings to be mirrored automatically for the passenger's temperature setting.

Comfort and Convenience

Climate Control

Touching the on-screen SYNC button will cause it to illuminate and automatically implement the driver's air temperature settings to the passenger's side.

The driver can exit SYNC mode at any time by a single touch of the SYNC button. The SYNC button on the screen will then extinguish.

Hot Evac

The Hot Evac feature can be activated from the vehicle settings menu. See Hot Evac, page 4.18.



NOTE: If a door is opened during the Hot Evac operation, the Hot Evac function will cancel.

Press and hold the key fob unlock button for 2 seconds, the Hot Evac feature will operate if switched on in the vehicle settings menu.

The following features operate during the Hot Evac operation:

- Climate control blower Speed to Maximum for 30 seconds
- Climate control temperature set to LO for 30 seconds
- Windows lower

A/C (screen) button

The A/C enhances the cooling and dehumidifying of air. It is used by max-cooling and defrosting modes.

Use the A/C screen button as an ON/OFF switch.

Comfort and Convenience

Climate Control

Demisting/Defrosting

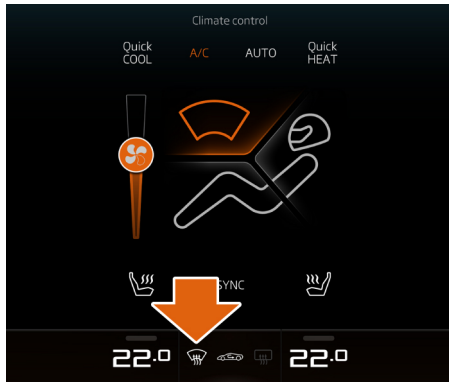





Touch the demist button to activate the screen demist function. The button will illuminate and an icon will be displayed at the top of the screen to indicate the function is active. The air conditioning switches on if previously off and the blower will operate at full speed with the air temperature set to 'HI'.

- i** NOTE: It is possible to manually reduce the blower speed, see Blower speed control, page 5.09.
- i** NOTE: Air recirculation is inhibited when demist mode is selected.

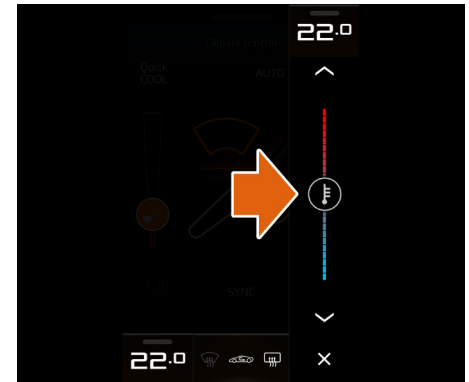
Touch the demist button again to exit the demist mode. The icon on the button extinguishes, and the air temperature and blower speed return to their original settings.

Temperature control





Touch the  button to increase the temperature, or touch the  button to decrease. Alternatively, touch the temperature control slider and drag it to the desired setting. To close the temperature control slider touch the  button.

- i** NOTE: The temperature can be adjusted in 0.5°C (1°F) increments from 16°C to 28°C (61°F to 83°F). McLaren recommend the temperature is set to 22°C (72°F).

Comfort and Convenience

Climate Control

To set the temperature to maximum, touch the  button until 'HI' is displayed. In AUTO mode, the climate control system adjusts the air temperature to the highest setting, the blower speed is set to maximum and air is directed to the footwells.

To set the temperature to minimum, touch the  button until 'LO' is displayed. In AUTO mode, the climate control system sets the air temperature to the lowest setting, the blower speed is set to maximum and air is directed to the centre air vents.

The temperature set will appear on the Central Infotainment Touchscreen.

 **NOTE:** With 'LO' selected, it is not possible to switch off the air conditioning.

Air recirculation mode

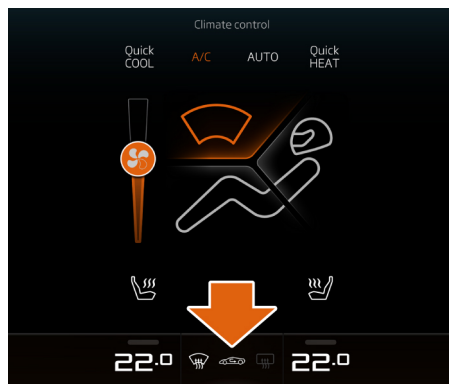

Select air recirculation when unpleasant smells or fumes are entering the vehicle. Air from outside the vehicle is now prevented from entering the cabin.

 **WARNING:** Switch to air recirculation mode briefly if outside temperatures are low. Be aware that the windows could mist up, which may impair your visibility. As a result, you could be distracted from road and traffic conditions and cause an accident.

 **NOTE:** Switch on the air conditioning to prevent the windows misting.

Touch the air recirculation button, to activate air recirculation. The button will illuminate. To switch off air recirculation, touch the button again and the button illumination will be extinguished.

Comfort and Convenience

Climate Control

Blower speed control



- i** NOTE: When the engine is first started, the blower speed is limited and the air is directed at the windscreen until the engine has warmed up.
- i** NOTE: When the engine is restarted from hot, the blower may operate at low speed. This removes warm air from the vents, the blower speed will then increase to the requested setting.

Touch the + button to increase the blower speed, or touch the - button to decrease blower speed. Alternatively, touch the fan icon and drag it to the desired setting.

If in automatic mode, adjusting the blower speed will cause the AUTO button to extinguish.

Press the AUTO button to return to automatic mode.

Air distribution settings



The air distribution can be set using the air distribution controls.

Press the top screen area to direct air to the windscreen, press the middle screen area to direct air to the centre air vents, press the bottom screen area to direct air to the footwell vents.

All three screen areas, a combination of any two or an individual area can be selected at any time.

When an air distribution screen area is pressed, the screen icon will illuminate.

Comfort and Convenience

Climate Control

Dashboard air vents





Turn a quarter turn in either direction until the vent is open or closed.

Central dashboard air vent

The central dashboard air vent can be opened and closed by pushing the centre blade.

Heated seats



-  **WARNING:** To avoid the risk of injury, constantly monitor the seat temperature.
-  **WARNING:** The heated seats will not switch off automatically once it reaches its optimum temperature dependent on the level selected. Please ensure the switch of the heated seat function is turned off once the desired heat/period of heat has been achieved.



Touch the button once to switch seat heating on to the low temperature setting, one bar on the button will illuminate. Touch the button again to switch to the medium temperature setting, two bars on the button will illuminate. Touch the button again to switch to the full temperature setting, three bars on the button will illuminate.

To switch off, touch the button again and the icon on the button will be extinguished.

The seat heater will remain in operation until switched off.

-  **NOTE:** Seat heating is only available when the engine is running. If seat heating is not available, the button will appear greyed out.
-  **NOTE:** Seat heating will switch off automatically when the engine is stopped by the Eco Start-Stop System, but will resume heating when the engine restarts. See Eco Start-Stop system, page 2.09.

Comfort and Convenience

Climate Control

Heated rear window

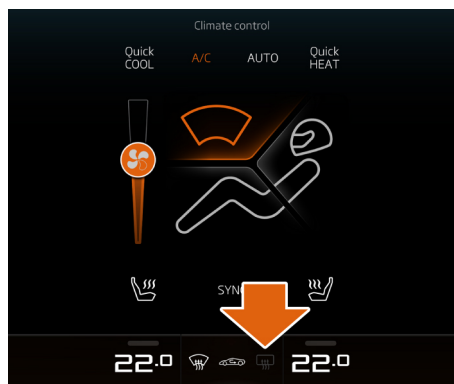

⚠ WARNING: Remove any accumulated ice or snow from the mirrors and windows before setting off. Impaired visibility could endanger yourself and others.

Touch the button to heat the rear window and exterior mirrors. The icon on the button will illuminate. To switch off, touch the button again and the icon on the button will be extinguished.

The heated rear window and mirrors switch off automatically after a set time, depending on the outside air temperature.

Comfort and Convenience Interior Features

Interior lighting

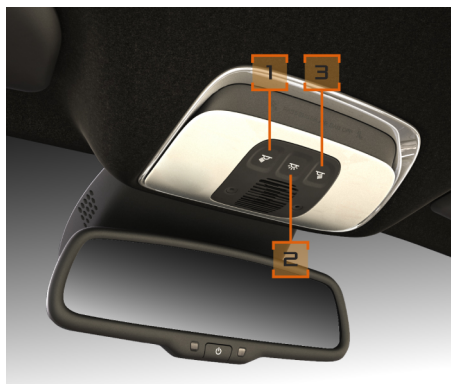

1. Left-hand reading light on/off/gradual touch pad
2. Interior lighting on/off touch pad
3. Right-hand reading light on/off/gradual touch pad

For full interior lighting, press the touch pad (2) quickly.



NOTE: Ensure that the interior lighting is switched off when leaving the vehicle.

To switch off the interior lighting, press touch pad (2) again.

Reading lights

Press touch pads (1) or (3) to switch on the desired reading light.

For gradual reading illumination, press and hold touch pad (1) or (3) until desired lighting is achieved.

Press touch pads (1) or (3) again to switch off the respective reading light.

Courtesy lighting

The interior of your McLaren is lit in the following areas:

- the driver's and passenger's footwells, when you open a door
- the centre console (illuminated by a light within the overhead light panel), if the ignition is on
- the interior door handles, if the ignition is on

The courtesy lighting extinguishes 60 seconds after the doors have been closed or when the ignition is switched on.

The luggage compartment light illuminates when the luggage compartment is opened.

Ambient lighting

The ambient lighting can be adjusted for colour and intensity using the McLaren Infotainment System (MIS) settings menu. See Light settings, page 4.16.

Comfort and Convenience Interior Features

Entry lighting

Entry lighting improves visibility and security when you approach the vehicle.

When the vehicle is unlocked, the headlamps and tail lamps illuminate for a period of time or until the ignition is switched on.

To set the entry lighting duration, see Light settings, page 4.16.

Exit lighting

Exit lighting improves visibility and security when you leave the vehicle by illuminating the headlamps and tail lamps for a period of time.

To set the exit lighting duration, see Light settings, page 4.16.

Exit lighting can also be activated manually by pulling the direction indicator stalk towards you momentarily three times. The vehicle must be in an Awake mode with the ignition off.

Every additional pull on the direction indicator stalk whilst the exit lighting has been activated will increase the time increment by an additional 15 seconds.

Once the vehicle has been exited, locked and completed its set operating time, the exit lighting will be extinguished and the function will not be available, unless it is switched on in the McLaren Infotainment System (MIS) or is manually activated again through the direction indicator stalk.

Electrochromic Roof



The electrochromic roof switch is located on the roof headliner, between the driver and the passenger. Depress the switch to activate the feature, the glass will become clear and the switch will illuminate, indicating that the feature is activated.

When the ignition is switched off, the feature will switch off and the glass will be tinted.

When the ignition is switched on, the glass will return to the previously set state.

Comfort and Convenience Interior Features

i NOTE: During roof operation, the glass will switch off (tinted) when roof is opened. It will return to the state prior to roof opening if the roof is then closed, providing the ignition has not been switched off.

Stowage compartments

Centre console stowage compartment - except 765LT



A compartment is fitted in the centre console for storing small items.

Depress the release button on the underside of the lid and lift to open. To close, push the lid down firmly and ensure that it is latched securely.

i NOTE: When the vehicle is locked or Valet Mode is on, the stowage compartment will be locked and the release button disabled.

! WARNING: The stowage compartment must be closed when items are stored in it. Occupants could be injured by objects being thrown around during sharp braking, a sudden change of direction or an accident.



The USB and a 3.5 mm auxiliary audio input sockets are located in the stowage compartment. See Connecting an external device, page 4.34.

Comfort and Convenience Interior Features

- i** NOTE: Always close the stowage compartment when leaving the vehicle, or the interior motion sensor (if fitted) will not function.
- i** NOTE: The area behind the seats is not designed for storing luggage or any other personal items.

Centre console stowage compartment - 765LT

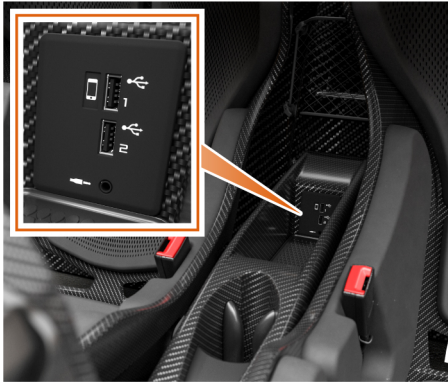

A compartment is fitted in the centre console for storing small items.

The USB and a 3.5 mm auxiliary audio input sockets are located in the stowage compartment. See Connecting an external device, page 4.34.

- i** NOTE: The area behind the seats is not designed for storing luggage or any other personal items.

Door stowage compartments - except 765LT



A compartment is fitted in each door for storing small items.

Pull the front edge of the lid to open, push back to close.

- !** **WARNING:** The stowage compartment must be closed when items are stored in it. Occupants could be injured by objects being thrown around during sharp braking, a sudden change of direction or an accident.

- !** **WARNING:** The stowage compartment must not be opened when the door is open as there is a risk of objects falling out.

- i** NOTE: The door stowage compartments are locked closed when the doors are open to prevent objects falling out. Do not try to force the door compartments open when they are locked.

Seat stowage pocket

A pocket is fitted to the front edge of the driver's seat for storing small items.

Rear luggage stowage

- !** **WARNING:** Large objects in the rear luggage area may obscure the drivers view, and prevent use of the rear view mirror.

Comfort and Convenience Interior Features

⚠ WARNING: Do not carry unsecured objects in the rear luggage area. Occupants could be injured by objects being thrown around during sharp braking, a sudden change of direction or an accident.

⚠ WARNING: McLaren does not accept any responsibility for damage or injury caused by moving luggage in the event of a collision, regardless of whether or not a McLaren luggage retention product is used.

⚠ WARNING: This vehicle is not designed to carry luggage anywhere outside the vehicle. McLaren accepts no responsibility for damage or injury caused by luggage being stowed outside the vehicle.

⚠ WARNING: Do not place any objects on the engine window (765LT) as this could cause damage to the window.

Please contact your McLaren retailer for information on luggage retention products and the correct usage of luggage retention products.

Cup holders



Utilise the cup holders for safe convenient storage of closed drink containers when on a journey.

⚠ WARNING: Drinking while the vehicle is moving could cause you to become distracted which could lead to an accident.

⚠ WARNING: Do not put any hot beverages in the cup holder while the vehicle is moving. Hot beverages could spill, which may cause injury.

⚠ WARNING: Do not use breakable beverage containers (for example, made out of glass or porcelain). You could be injured by them in the event of an accident.

i NOTE: Beverage containers in the cup holders should always have a lid. If not, beverages could spill and cause damage to the vehicle equipment, such as electronics or seat covers.

Comfort and Convenience

Interior Features

Owner documentation

Your McLaren is equipped with the following documents:

- Service and Warranty Guide - provides information on what to do and who to contact in the event of problems.
- Owner's Handbook - provides information on how to operate your McLaren.



The Service and Warranty Guide can be stored in a slot under the dashboard on the passenger's side.

Sun visors



Fold the sun visors down to protect your eyes from bright sunlight as you are driving.

Vanity mirrors

Slide the panel on the sun visors to reveal a personal mirror.

Accessory power sockets

Luggage compartment socket



The accessory socket, located in the luggage compartment, has a maximum load rating of 20 Amps and is the only one that can be used to connect a McLaren supplied battery charger.

i NOTE: Do not leave any device (except a McLaren supplied battery charger), that draws power from the vehicle, connected to the socket for extended periods without the engine running. This may lead to excessive battery drain.

Comfort and Convenience Interior Features

Interior accessory 12 V socket



The interior accessory 12 V socket is located adjacent to the front cup holder in the centre console and has a maximum load rating of 15 Amps.

i NOTE: Do not connect a battery charger to the interior accessory socket.

USB sockets

Media USB sockets



The media USB sockets are located inside the centre console stowage compartment.

The two media USB sockets can be used to connect USB flash drives, iPods and other compatible MP3 players.

These sockets can also be used to charge compatible mobile phones or media devices.

i NOTE: The USB1 port has a high power output suitable for charging mobile devices.

McLaren 

Maintaining Your McLaren

Fluid Topping Up.....	6.04	Lighting.....	6.26
Engine oil.....	6.04	Vehicle lights.....	6.26
Gearbox oil level.....	6.06	Manual Unlocking and Opening.....	6.27
Coolant.....	6.07	Unlocking - discharged battery.....	6.27
Power steering fluid.....	6.09	Starting the vehicle.....	6.28
Brake fluid.....	6.10	Door opening from inside - discharged battery.....	6.29
Windscreen washers.....	6.11	Opening luggage compartment - discharged battery.....	6.29
Emergency Equipment.....	6.12	Replacing key fob battery.....	6.32
Emergency equipment safety.....	6.12	Washers and Wipers.....	6.33
Luggage compartment equipment.....	6.12	Replacing the wiper blades.....	6.33
Warning triangle.....	6.12	Wheels and Tyres.....	6.35
First aid kit.....	6.13	Wheels and tyres.....	6.35
Tyre sealant.....	6.13	Deflated tyre.....	6.39
Towing eye.....	6.14	Vehicle Care.....	6.41
Fuel funnel.....	6.14	Washing your McLaren.....	6.41
Service cover release tool.....	6.14	Cleaning the interior.....	6.42
Manual door release key holder.....	6.15	Car cover.....	6.43
Fire extinguisher.....	6.15	Raising the Vehicle.....	6.44
Battery Care and Maintenance.....	6.16	Vehicle lifting points.....	6.44
Battery safety.....	6.16	McLaren Assistance.....	6.45
Charging the battery.....	6.16	McLaren assistance.....	6.45
Boost starting from another vehicle.....	6.17	Replacement battery.....	6.45
Fuses.....	6.19	In the event of a breakdown.....	6.45
Fuse replacement.....	6.19	Towing for recovery.....	6.46
Main fuse box.....	6.19		
Secondary fuse box.....	6.22		
Battery fuse box.....	6.24		

Maintaining Your McLaren

Driving Abroad.....6.47
Driving abroad.....6.47

Maintaining Your McLaren Fluid Topping Up

Engine oil

It is normal for your engine to consume oil and the rate of consumption will vary with many factors. The oil consumption may be higher when the vehicle is new or if you frequently drive at high engine speeds.

It is important to follow the service schedule for oil and filter changes and to regularly check the level of your oil in between.

You will only be able to estimate the oil consumption after the vehicle has been driven for several thousand miles or kilometres.

i NOTE: Lubricant additives could damage the engine or gearbox. Damage caused by such additives is not covered by the vehicle warranty. Further information is available from your McLaren retailer.

i NOTE: The oil pressure warning light is not a low oil level indicator.

Checking the engine oil

1. Ensure the following conditions are met:
 - Vehicle stationary and positioned on a level surface.
 - Neutral selected and the foot brake applied (use left foot).

i NOTE: The foot brake must be applied for the entire duration of the oil level check.

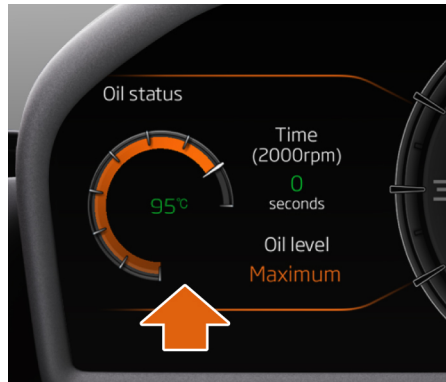

2. The level is viewed in the Vehicle Info section on the Folding Driver Display, see Oil status, page 3.08.
3. Start the engine and hold the engine speed at 2,000 rpm for 120 seconds. Allow the engine oil temperature to reach a temperature of 90°C (194°F).

i NOTE: The throttle pedal can be fully depressed as the engine speed will be electronically limited to 2,000 rpm.

4. When the timer has reached '0', the oil level will be shown on the Folding Driver Display along with a description.

i NOTE: The line on the display indicates the maximum oil level for 19 seconds after the oil level is read.

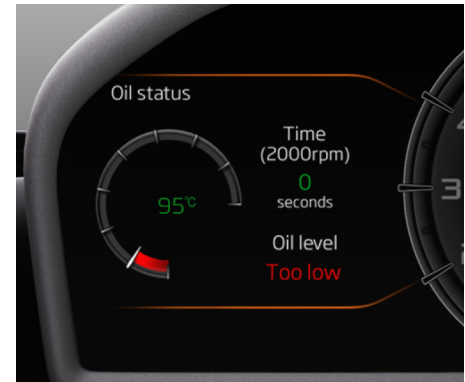

5. If the engine oil is below the target level, top up the oil in accordance with the following procedure.

Maintaining Your McLaren Fluid Topping Up

i NOTE: Once the oil level check has been completed and returned a value, do not continue to test the system. This may lead to aeration of the oil and return a false value. To end the oil level check, release the throttle pedal and return to the Vehicle info menu by moving the menu stalk back.

Topping up the engine oil

! **WARNING:** There is a risk of injury if the service cover is removed, even when the engine is not running. Engine components become very hot and there is a risk of severe burns. The engine ignition system carries a high voltage. Never touch ignition system components; ignition coils, ignition wiring (spark plug connections).

1. Remove the service cover.
See Service cover - 720S and 765LT Coupe, page 1.11.
See Service covers - 720S and 765LT Spider, page 1.13.



2. Unscrew the engine oil filler cap.
3. Top up with the correct quantity of engine oil. Refer to Top up quantity, page 6.05.
4. Check the Folding Driver Display to ensure level is correct.

i NOTE: If you have inadvertently overfilled the engine with oil, you must have any excess removed at your McLaren retailer. The engine or the catalytic converter could be damaged.

5. Refit the engine oil filler cap.

🌿 ENVIRONMENTAL: When topping up, take care not to spill any oil. Oil must not be allowed to escape into the soil or waterways.

i NOTE: Ensure the oil filler cap is refitted correctly.

6. Install the service cover
See Service cover - 720S and 765LT Coupe, page 1.11.
See Service covers - 720S and 765LT Spider, page 1.13.

Top up quantity

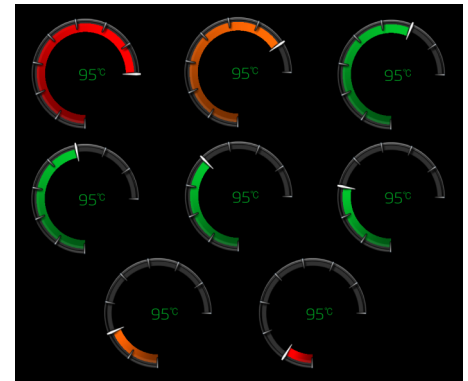

Maintaining Your McLaren Fluid Topping Up

Based on the oil status displayed on the Folding Driver Display, add the required quantity of oil as shown in the following table, then check the engine oil level again.

Segments on display	Quantity of oil required
1 - red - under filled	0.90 litre
2 - amber - min.	0.70 litre
3 - green - OK	0 litre
4 - green - OK	0 litre
5 - green - OK	0 litre
6 - green - OK	0 litre
7 - amber - max.	0 litre
8 - red - overfilled	Contact your McLaren retailer

Oil temperature

If the oil temperature is too high, a warning will be displayed on the Folding Driver Display. Reduce the vehicle and engine speed until the warning message disappears.

Gearbox oil level

If you experience oil loss or problems with gear shifts, have the gearbox checked by your McLaren retailer.

 **NOTE:** The clutch and gearbox oil has mileage related service intervals. This maintenance can only be carried out by your McLaren retailer.

Maintaining Your McLaren Fluid Topping Up

Coolant

Coolant is a mixture of water and antifreeze/corrosion inhibitor. Only check the coolant when the vehicle is positioned on level ground and the engine is cool.

Topping up the coolant - 720S and 765LT Coupe

⚠ WARNING: There is a risk of injury if the service cover is removed, even when the engine is not running. Engine components become very hot and there is a risk of severe burns. The engine ignition system carries a high voltage. Never touch ignition system components; ignition coils, ignition wiring (spark plug connections).

1. Remove the service cover.
See Service cover - 720S and 765LT Coupe, page 1.11.
2. Slowly unscrew the cap by half a turn anti-clockwise and allow excess pressure to escape.
3. Unscrew the cap fully and remove it.

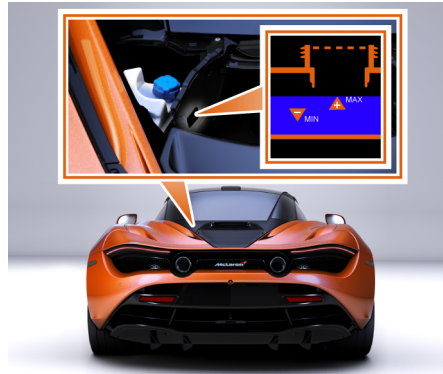

4. The coolant level is correct when it is at the top of the + marker.
5. Top up the coolant if necessary. See Coolant, page 7.16.
6. Replace the cap by turning it clockwise to the stop.
7. Install the service cover.
See Service cover - 720S and 765LT Coupe, page 1.11.

Topping up the coolant - 720S and 765LT Spider

⚠ WARNING: There is a risk of injury if the service covers are removed, even when the engine is not running. Engine components become very hot and there is a risk of severe burns. The engine ignition system carries a high voltage. Never touch ignition system components; ignition coils, ignition wiring (spark plug connections).

1. Remove the service covers.
See Service covers - 720S and 765LT Spider, page 1.13.
2. Remove the service cover release tool from the tool kit.

Maintaining Your McLaren Fluid Topping Up

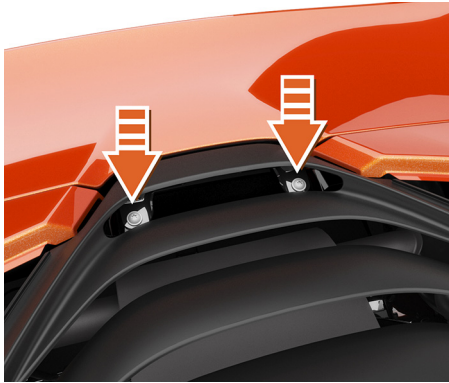

- Using the service cover release tool, rotate the two captive fixings 90° anti-clockwise to release the rear of the rear deck vent.

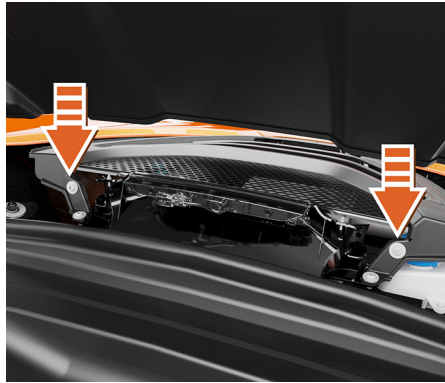

- Using the service cover release tool, rotate the two captive fixings 90° anti-clockwise to release the front of the rear deck vent.
- Lift the rear deck vent to remove.
- i** **NOTE:** Place the rear deck vent inside the vehicle to avoid the risk of damage.
- Slowly unscrew the cap by half a turn anti-clockwise and allow excess pressure to escape.
- Unscrew the cap fully and remove it.



- The coolant level is correct when it is at the top of the + marker.
- Top up the coolant if necessary. See Coolant, page 7.16.
- Replace the cap by turning it clockwise to the stop.
- Replace the rear deck vent, securing with the four bolts.
- Install the service covers.
See Service covers - 720S and 765LT Spider, page 1.13.

Maintaining Your McLaren Fluid Topping Up

Power steering fluid

⚠ WARNING: Power steering fluid is highly flammable. Fire, naked flames and smoking are prohibited when handling power steering fluid.

⚠ WARNING: Power steering fluid is toxic. Keep containers sealed and away from children. If fluid is accidentally consumed, seek medical help straight away.



Right-hand drive models

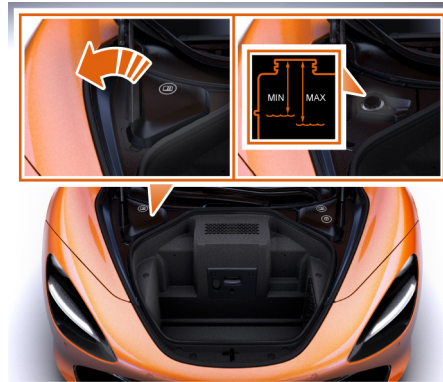

Left-hand drive models





Checking fluid level

1. Switch the ignition on and start the engine. Select Comfort handling mode, see Handling control, page 2.22.
2. Allow the engine to idle for 20 seconds before checking the fluid level.
3. Open the luggage compartment, see Front luggage compartment, page 1.14.
4. Remove the access cover, then unscrew the cap anti-clockwise and remove it.

5. Measure the distance, inside the reservoir, down to the fluid level. Maximum fill level is 50 mm and minimum fill level is 55 mm from the top of the filler neck.
6. Top up if necessary using only Pentosin CHF202 power steering fluid, contact your McLaren retailer.
7. Replace the cap and access cover.
8. Close the luggage compartment, see Front luggage compartment, page 1.14.

Maintaining Your McLaren Fluid Topping Up

Brake fluid

-  **WARNING:** Brake fluid is highly flammable. Fire, naked flames and smoking are prohibited when handling brake fluid.
-  **WARNING:** Brake fluid is toxic. Keep containers sealed and away from children. If fluid is accidentally consumed, seek medical help straight away.
-  **WARNING:** Only use fluid from new, air tight containers.
-  **NOTE:** Avoid spilling brake fluid, it is harmful to painted surfaces. Any spillages must be removed immediately with a mixture of car shampoo and water.
-  **NOTE:** The engine must be switched off before carrying out the brake fluid check and top up process.



Right-hand drive models



Left-hand drive models

Checking fluid level

1. Open the luggage compartment, see Front luggage compartment, page 1.14.
2. Remove the access cover, then unscrew the cap anti-clockwise and remove it.
3. The brake fluid is correct if the level just covers the base of the filter in the filler neck.
4. Top up if necessary using only new Pentosin DoT 5.1 brake fluid.
5. Replace the cap and access cover.

Maintaining Your McLaren Fluid Topping Up

6. Close the luggage compartment, see Front luggage compartment, page 1.14.

Windscreen washers

 **WARNING:** Some washer fluids are highly flammable. Fire, naked flames and smoking are prohibited when handling washer fluid.

 **WARNING:** Washer fluid is toxic. Keep containers sealed and away from children. If fluid is accidentally consumed, seek medical help straight away.

 **NOTE:** Add washer fluid to the reservoir all year round.

The reservoir for the windscreen washers is located in the luggage compartment.

The reservoir has a capacity of approximately 2.5 litres.

Checking fluid level

1. Open the luggage compartment, see Front luggage compartment, page 1.14.
2. Mix a solution of screenwash concentrate and water in a container before adding to the reservoir. Concentration of the washer solution should be mixed to suit the outside temperatures.



3. Remove the access cover.
4. Open the reservoir cap, top up the reservoir with washer fluid and close the cap.
5. Replace the access cover.
6. Close the luggage compartment, see Front luggage compartment, page 1.14.

Maintaining Your McLaren Emergency Equipment

Emergency equipment safety

Before using the emergency equipment, familiarise yourself with the following safety information.

 **WARNING:** Always ensure the emergency equipment supplied is used in the proper manner and for the purpose it was designed. Always use the emergency equipment in a safe and responsible manner and be aware of other road users.

Luggage compartment equipment



 **NOTE:** The towing eye is supplied fitted inside the first aid kit case, the fuel funnel is supplied with the vehicle.

Warning triangle



The warning triangle (1) is located at the front of the luggage compartment.

Maintaining Your McLaren Emergency Equipment

Setting up the warning triangle

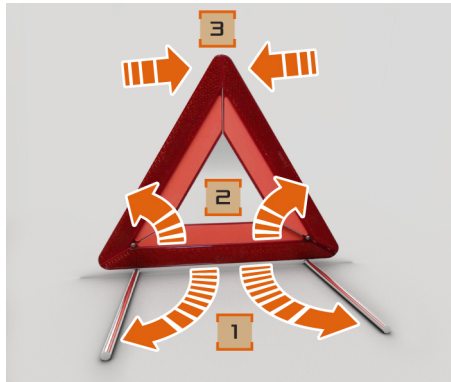

Fold the legs (1) sideways from the bottom.
Pull side reflectors (2) upwards to form a triangle and lock them at the top using press-stud (3).
Place the warning triangle at an appropriate distance from the vehicle to warn other traffic of a breakdown.

First aid kit



The first aid kit (2) is located at the front of the luggage compartment.

i NOTE: Check the expiry dates of the first aid kit materials every 12 months, and replace them if necessary.

Tyre sealant



The tyre sealant (3) is located at the front of the luggage compartment.

For instructions on how to use the tyre sealant, see Deflated tyre, page 6.39.

i NOTE: Check the expiry date of the tyre sealant every 12 months, and replace if necessary.

Maintaining Your McLaren Emergency Equipment

Towing eye



The towing eye (4) is located inside the first aid kit case at the front of the luggage compartment.

i NOTE: Your McLaren is equipped with a front towing eye mounting only. It is not possible to tow other vehicles.

For information on installing the towing eye, see Towing eye and mounting, page 6.46.

Fuel funnel



The fuel funnel (5) is supplied with the vehicle.

i NOTE: Only use the fuel funnel when filling the vehicle with fuel from sources other than a fuel pump on a garage forecourt.

Do not use the fuel funnel when topping up coolant, engine oil or any other fluids in the vehicle.

Service cover release tool



The service cover release tool (6) is located inside the first aid kit case at the front of the luggage compartment.

Maintaining Your McLaren Emergency Equipment

Manual door release key holder



The manual door release key holder (7) is supplied with the vehicle.

- i** NOTE: The manual door release key holder is used to assist with turning the mechanical key in order to gain access to the vehicle if the vehicle battery or key fob battery has become discharged. Therefore, the manual door release key holder should not be kept inside the vehicle.

Fire extinguisher



The fire extinguisher is located at the rear of the luggage compartment.

Release the retaining strap and remove the fire extinguisher.

To operate, follow the manufacturer's instructions on the side of the fire extinguisher.

- i** NOTE: The fire extinguisher must be checked every 12 months or it may fail in an emergency. Once the extinguisher is used it will have to be replaced.

Maintaining Your McLaren

Battery Care and Maintenance

Battery safety

Before using the battery charger, familiarise yourself with the following safety information.

- WARNING:** Your McLaren is fitted with a lithium-ion battery. Only a lithium-ion battery charger can be used on this type of battery. Contact your McLaren retailer for more information.
- WARNING:** The lithium-ion battery fitted to your McLaren is sealed for life and no attempt should be made to break the battery seal to inspect the battery cells.
- WARNING:** Leave a suitable lithium-ion battery charger connected to the lithium-ion battery and switched on during periods when your vehicle is not in regular use. This will help maintain and prolong the life of the battery.
- WARNING:** Before use, check that all cables are in good condition; do not use cables that are damaged.

Ensure that all cables are kept away from sharp edges, are not pinched or trapped and are not close to hot surfaces or water.

Never charge a damaged battery. The battery must only be charged in a well ventilated area; the charger must never be covered or placed on the battery.

Do not place any metal objects on a battery. You could cause a short circuit and the battery could ignite. Keep the charger out of reach of children at all times.

Charging the battery

- NOTE:** To maintain your lithium-ion battery in optimum condition, always leave the McLaren supplied battery charger connected to the battery and switched on during periods when your vehicle is not in regular use.
- NOTE:** Do not connect the battery charger to the interior accessory socket.



Refer to the instructions supplied with the battery charger. The charger connects to the accessory socket in the luggage compartment.

Maintaining Your McLaren

Battery Care and Maintenance

Boost starting from another vehicle

Using booster cables

⚠ WARNING: Ensure that both batteries are 12 V and that the booster cables have insulated clamps and are approved for use with 12 V batteries.

⚠ WARNING: Do not connect positive (+) terminals to negative (-) terminals.

⚠ WARNING: Take care when working near rotating parts of the engine. Ensure cables are kept well clear.

i NOTE: Do not use a 24 V booster start system. These produce excessive voltage and can damage the vehicle's electrical system.

i NOTE: It is not possible to push or tow start a vehicle with a discharged battery.

i NOTE: If using a donor vehicle, please allow it to have the engine running for a minimum of 2 minutes before trying to start the disabled vehicle.

Boosting procedure

1. If a donor vehicle is to be used, park it so that the battery location is adjacent, but ensure the two vehicles do not touch.
2. Apply the parking brake and ensure that the transmission of both vehicles is set in neutral (or park for vehicles with automatic transmission).
3. Switch off the ignition and all electrical equipment in both vehicles.
4. Open the luggage compartment and remove any items stowed inside.



5. Remove the 2 quarter turn screws securing the top of the battery access cover.



6. Open the top of the battery access cover and disconnect the 2 electrical connectors on the back of the cover.
7. Lift the battery access cover upwards, off its locating pegs, and remove.

i NOTE: Before connecting the booster cables, ensure that the battery terminals on the disabled vehicle are correctly and securely connected and that all electrical equipment has been switched off.

Maintaining Your McLaren Battery Care and Maintenance



8. Connect one end of the positive (+) booster cable to the positive (+) terminal on the donor vehicle's battery.
9. Connect the other end of the positive (+) booster cable to the positive (+) terminal tab on the disabled vehicle's battery (A).
10. Connect one end of negative (-) booster cable to the negative (-) terminal on the donor vehicle's battery.
11. Connect the other end of the negative (-) booster cable to the negative (-) terminal on the disabled vehicle's battery (B).

12. Check that the cables are clear of any moving components and that all four connections are secure.



WARNING: Ensure that each connection is securely made and that there is no risk of the clips accidentally slipping or being pulled from the connection points/battery terminal - this could cause sparking, which could lead to fire or explosion.

13. Start the engine of the donor vehicle and allow it to run for 2 minutes.
14. The electrical system on the disabled vehicle should now be ready for the engine to be started.
15. Start the engine of the disabled vehicle.
16. Allow both vehicles to idle for 2 minutes.
17. Switch off the donor vehicle.



NOTE: Do not switch on any electrical circuits on the previously disabled vehicle until after the booster cables have been removed.



NOTE: If battery is fully discharged, or has been disconnected, it may be necessary to reset the windows, see Resetting the windows, page 5.02. If this does not resolve the issue, please contact your McLaren retailer immediately.

Disconnecting the cables

1. Disconnect the booster cables in the reverse order to that used for connection.
2. Refit the battery access cover, connect the 2 electrical connectors and secure with the 2 screws.

Maintaining Your McLaren Fuses

Fuse replacement

⚠ WARNING: Fuses protect the vehicle's electrical systems. The failure of any fuse will render the system it protects inoperative. Use replacement fuses of the same rating and type. Incorrect fuse ratings can overload a system and cause a fire or malfunction. Blown fuses should be replaced and no attempt should be made to repair a blown fuse.

i NOTE: Before removing a fuse, turn off all electrical equipment and switch off the ignition.

There are three fuse boxes fitted to your McLaren.

Fuse Box	Location
Main fuse box	Behind a panel in the rear bulkhead, behind the left-hand seat.
Secondary fuse box	Below the dashboard on the passenger's side.

Battery fuse box	On top of the battery, in the luggage compartment, beneath the luggage compartment cover.
------------------	---

Main fuse box

Main fuse box access



1. To access the main fuse box:
 - if a manual seat is fitted, lift the tilt release lever and tilt the left-hand seat backrest forwards
 - if an electric seat is fitted, pull the release strap (shown above) and tilt the left-hand seat backrest forwards
 - if a race seat is fitted, slide the seat forwards

Maintaining Your McLaren Fuses



2. Release the two lower clips securing the panel to the bulkhead and remove the panel
3. Refer to the fuse specification to determine which fuse protects the non-functioning electrical system, see Main fuse box fuse specification chart, page 6.20.

i NOTE: A label identifying the fuses is attached to the inside of the access panel.

4. Remove the appropriate fuse and replace it with a fuse of the same value as the original. If in doubt, check the fuse specification chart.

5. Fit the access panel by inserting the two upper retaining clips in the bulkhead and securing with the two lower clips.

i NOTE: If a replacement fuse does not solve the electrical problem, or it fails immediately, contact your McLaren retailer.

Main fuse box fuse specification chart

No.	Amps	Circuit protected
F1	60	Right-Hand Secondary Air Pump
F2	60	Left-Hand Secondary Air Pump
F3	20	Tonneau Motor Right-Hand (Spider Models Only)
F4	20	Tonneau Motor Left-Hand (Spider Models Only)
F5	30	Transmission Control Unit
F6	30	Transmission Control Unit
F7	30	Starter

No.	Amps	Circuit protected
F8	30	Heated Rear Window
F9	30	Audio Amplifier (16 Channel)
F10	20	Roof Central ECU (Spider Models Only)
F11	20	Roof Central ECU (Spider Models Only)
F12	20	Roof Main Motor Left-Hand (Spider Models Only)
F13	5	Transmission Control Unit
F14	5	Engine Control Module
F15	10	Relays
F16	-	-
F17	3	Door Locking Switch
F18	50	ECU Main Relay Feed
F19	40	Fuel Pump

Maintaining Your McLaren Fuses

No.	Amps	Circuit protected
F20	30	Seat Driver's
F21	30	Seat Passenger's
F22	20	Roof Main Motor Right-Hand (Spider Models Only)
F23	5	Tilt and Microwave Sensor
F24	20	Infotainment Control Unit
F25	10	Driver's/Passenger's Door Latch
F26	3	Auxiliary USB Board
F27	-	-
F28	-	-
F29	-	-
F30	-	-
F31	50	Cooling Fan Left-Hand
F32	50	Cooling Fan Right-Hand

No.	Amps	Circuit protected
F33	-	-
F34	-	-
F35	-	-
F36	20	ECM Power Supply
F37	15	Canister Purge, Lambda Sensors, Cooling Fan Relay Coil
F38	15	Fuel Injection and Ignition - Left-Hand Bank
F39	15	Fuel Injection and Ignition - Right-Hand Bank
F40	10	Engine Ancillaries
R41	-	-
R42	-	-
R43	-	-
R44	-	-

No.	Amps	Circuit protected
F45	10	Electrical Thermostats, Camshaft Actuators
F46	3	Output Shaft Speed, Even Gear Shaft Speed
F47	3	Input Shaft Speed, Odd Gear Shaft Speed
F48	-	-
F49	5	Starter
R50	-	-
R51	-	Heated Rear Window
R52	-	-
R53	-	Transmission Control Unit
R54	-	Transmission Control Unit
R55	-	Starter
R56	-	Secondary Air Pump RH

Maintaining Your McLaren Fuses

No.	Amps	Circuit protected
R57	-	Cooling Fans
R58	-	ECU Main relay Feed

Secondary fuse box

Secondary fuse box access

1. Access to the secondary fuse box is gained by lowering the closing panel below the dashboard on the passenger's side.



2. Remove the two front screws (1).
3. Remove the side fixing clip (2).

i NOTE: If you wish to lower the closing panel fully, also remove the two clips at the rear (3).

4. Lower the closing panel, sufficiently to gain access to the fuse box.

i NOTE: Do not lower the closing panel further than necessary as it could be damaged.



5. Remove the appropriate fuse and replace it with a fuse of the same value as the original. If in doubt, check the fuse specification chart, see Secondary fuse box fuse specification chart, page 6.23.
6. Raise the closing panel into position, fit the clip and fit and tighten the two front screws.

Maintaining Your McLaren Fuses

Secondary fuse box fuse specification chart

No.	Amps	Circuit protected
F1	20	Driver's Door
F2	20	Passenger's Door
F3	25	Lights
F4	35	Lights
F5	35	Body
F6	35	Body
F7	35	Alarm
F8	-	-
F9	-	-
F10	-	-
F11	-	-
F12	-	-
F13	-	-

No.	Amps	Circuit protected
F14	5	Transmission Control Unit
F15	10	Air Conditioning
F16	3	Alarm Control Unit
F17	3	Tracker
F18	7.5	Alarm
F19	5	Central Display
F20	3	Transmission Control Unit Relays
F21	15	Display Control Unit
F22	-	-
F23	5	Driver Display
F24	10	Development Connector
F25	10	OBD2 Diagnostics
F26	-	-

No.	Amps	Circuit protected
F27	-	-
F28	-	-
R29	-	Transmission Control Unit
R30	-	Transmission Control Unit

Maintaining Your McLaren Fuses

Battery fuse box

Battery fuse box access

1. Open the luggage compartment lid and remove any items stowed inside.



2. Remove the 2 quarter turn screws securing the top of the battery access cover.



3. Open the top of the battery access cover and disconnect the 2 electrical connectors on the back of the cover.
4. Lift the battery access cover upwards, off its locating pegs, and remove.

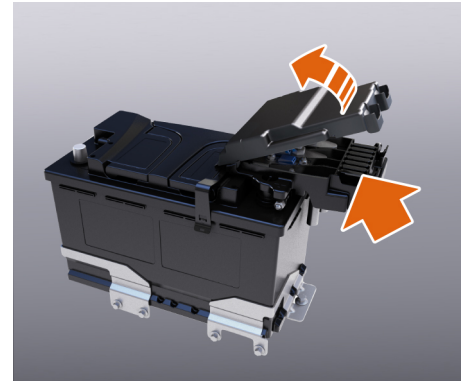

5. Press the 2 catches on the right-hand side of the cover and remove the cover from the fuse box.

Maintaining Your McLaren Fuses

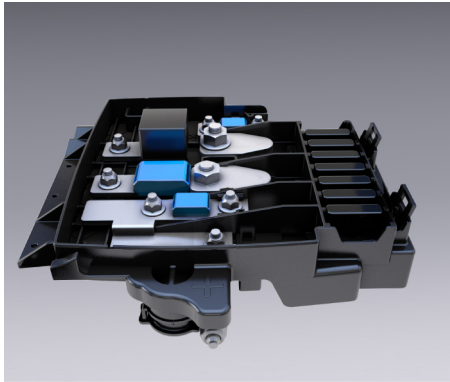

6. Remove the appropriate fuse and replace it with a fuse of the same value as the original. If in doubt, see Battery fuse box fuse specification chart, page 6.25.
7. Engage the left-hand side of the cover with the fuse box, and push the right-hand side down to fully engage the clips.
8. Refit the battery access cover, connect the 2 electrical connectors and secure with the 2 screws.
9. Stow the contents removed from the luggage compartment.

Battery fuse box fuse specification chart

No.	Amps	Circuit protected
F1	30	Transmission Control Unit
F2	30	Transmission Control Unit
F3	30	Air Conditioning - Motor - Control Module
F4	50	Secondary Fuse Box Supply
F5	40	Electronic Stability Control Valves
F6	40	Electronic Stability Control Motor
F7	20	Auxiliary Power Socket - Luggage Compartment
F8	40	Secondary Fuse Box Supply
F9	100	Electro Hydraulic Power Assisted Steering
F10	200	Main Fuse Box Supply

No.	Amps	Circuit protected
F11	30	Secondary Fuse Box Supply

Maintaining Your McLaren Lighting

Vehicle lights

Lighting is an important aspect of vehicle safety. You must ensure that all lights are working at all times.

All the external lights on your McLaren use the latest light-emitting diode technology.

Unlike traditional filament bulbs, these lights have a long life and low power consumption while providing the same amount of illumination.

Headlamps

Your McLaren is fitted with light-emitting diode headlamps. These provide greater visibility on both dipped and main beams, especially during adverse weather and driving conditions.



NOTE: Do not attempt to change light-emitting diode yourself, as you could damage the vehicle lighting systems. In case of failure, contact your McLaren retailer.

Maintaining Your McLaren Manual Unlocking and Opening

Unlocking - discharged battery

If you are unable to lock or unlock the vehicle because the vehicle battery or key fob battery has become discharged, use the mechanical key.

Unlocking and opening procedure



1. Push against the thumb indent and slide the back cover away from the key fob.



2. Release and remove the mechanical key from the key fob.



3. Insert the mechanical key into the manual door release key holder.
See Manual door release key holder, page 6.15

Maintaining Your McLaren Manual Unlocking and Opening



4. Insert the mechanical key into the lock and, turn the key anti-clockwise until mechanical resistance is preventing full release of the door.
5. Apply pressure to the latch area of the door (to counteract pressure of the door seals), and turn the key further to release the door.
6. Fit the mechanical key back into the key fob.

i NOTE: Unlocking the vehicle using the mechanical key will activate the anti-theft system and may cause the alarm to sound. Once the door is open, place the key fob on the section of the cup holder housing immediately behind the switch panel within 10 seconds. The vehicle will recognise the key fob and stop the alarm from sounding.

7. If the key fob battery has become discharged, replace the battery at the earliest possible opportunity, see Replacing key fob battery, page 6.32.

Starting the vehicle



If the key fob battery has become discharged, and the engine will not start, place the key fob on the section of the cup holder housing immediately behind the switch panel.

In this position the vehicle is able to sense the presence of the valid key fob and the vehicle can be started and driven.

Replace the key fob battery at the earliest possible opportunity, see Replacing key fob battery, page 6.32.

Maintaining Your McLaren Manual Unlocking and Opening

Door opening from inside - discharged battery



To release a door from inside, release the manual door release strap retainer and pull the strap.

The door latch will then release, allowing the door to be partially raised before it automatically swings outwards and upwards.

To refit the release strap, feed the strap into its holder and snap the retainers into place.

- i** NOTE: Only use this strap when the battery has become discharged.

- i** NOTE: Please ensure that both of the retainers on the manual door release strap are fitted correctly, and in the correct positions on the door aperture after use.
- i** NOTE: Please ensure that the manual door release strap is fully retracted before fitting the retainers to their door aperture locations.

Opening luggage compartment - discharged battery

- i** NOTE: The key fob or luggage compartment button on the centre console will not release the luggage compartment if the battery is discharged or disconnected. In the event of this use the manual release mechanism.

Opening procedure

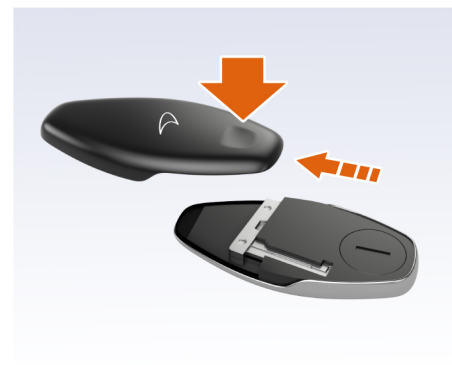

1. Push against the thumb indent and slide the back cover away from the key fob.

Maintaining Your McLaren Manual Unlocking and Opening

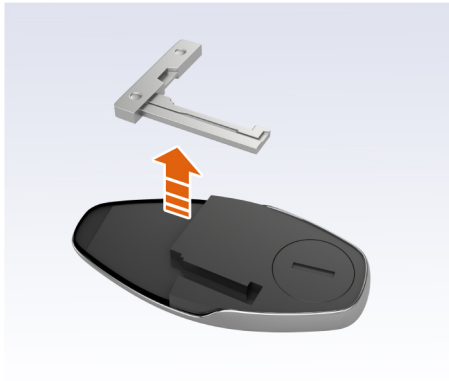

2. Release and remove the mechanical key from the key fob.



3. Insert the mechanical key into the manual door release key holder.
See Manual door release key holder, page 6.15



4. Insert the mechanical key into the lock and, turn the key anti-clockwise until mechanical resistance is preventing full release of the door.
5. Apply pressure to the latch area of the door (to counteract pressure of the door seals), and turn the key further to release the door.

Maintaining Your McLaren Manual Unlocking and Opening

i NOTE: Unlocking the vehicle using the mechanical key will activate the anti-theft system and may cause the alarm to sound. Once the door is open, place the key fob on the section of the cup holder housing immediately behind the switch panel within 10 seconds. The vehicle will recognise the key fob and stop the alarm from sounding.



6. The mechanical lock is located in the front left-hand air duct.

7. Apply pressure to the McLaren badge on the luggage compartment lid (to counteract pressure of the seals), and turn the key further to release the lid.
8. The luggage compartment will fully unlock and open slightly.



9. Lift the luggage compartment lid and release the safety latch.

10. Open the luggage compartment lid, the gas struts will support it in the fully open position.
11. Fit the mechanical key back into the key fob.
12. If the key fob battery has become discharged, replace the battery at the earliest possible opportunity, see Replacing key fob battery, page 6.32.

Maintaining Your McLaren Manual Unlocking and Opening

Replacing key fob battery



1. Push against the thumb indent and slide the back cover away from the key fob.

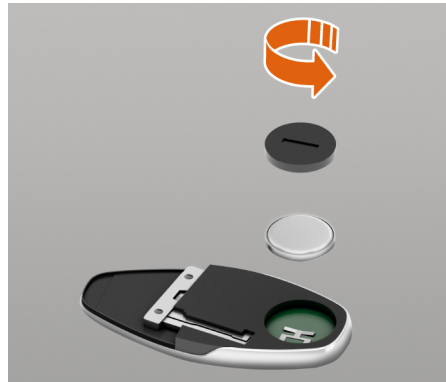

2. Unscrew the battery cover and remove the discharged the battery.
3. Install a new battery, ensuring that the polarity is correct.

i NOTE: Handle the battery as little as possible. Moisture and oil from fingers can affect battery life and cause corrosion of the contacts. Only hold the battery on the edges.

4. Refit the battery cover, ensuring that the seal is seated correctly.
5. Refit the key fob the back cover.

Maintaining Your McLaren Washers and Wipers

Replacing the wiper blades

⚠ WARNING: Ensure the ignition is switched off before you replace the wiper blades. The windscreen wipers could be set in motion and injure you.

⚠ WARNING: Replace the wiper blades every 12 months or the windscreen will not be wiped properly. You may not be able to observe the road and traffic conditions as a result and could cause an accident.

Parking the wiper blades

1. Press the STOP/START button once to switch on the ignition but **DO NOT** touch the brake pedal.
2. Pull the wiper control stalk towards you twice, the wipers will move to a winter park position and then to the service park position.

The winter park position locates the wiper arms vertically to aid water run-off and help prevent snow build-up.

The service park position locates the wiper arms in a convenient position for wiper blade replacement.

To remove the main wiper blade



1. Position the wiper blades in the service park position on the windscreen see Parking the wiper blades, page 6.33.
2. Lift the main wiper arm from the screen.
3. Rotate the wiper blade through 90° and remove in the direction of the arrow.

i NOTE: Never open the luggage compartment lid when the wiper arms are positioned away from the windscreen. You could damage the luggage compartment lid and/or the wiper arms.

i NOTE: Do not lower the wiper arms onto the windscreen without the wiper blades fitted.

To install a new main wiper blade

1. Slide the wiper blade onto the wiper arm and rotate 90°.

i NOTE: Ensure the wiper blade is securely fitted in the wiper arm.

2. Lower the wiper arms onto the windscreen.
3. Pull the wiper control stalk towards you once, the wipers will move back to the normal park position.

Maintaining Your McLaren Washers and Wipers

To remove the small wiper blade



1. Position the wiper blades in the service park position on the windscreen see Parking the wiper blades, page 6.33.
2. Lift the small wiper arm from the screen.
3. Depress the wiper blade clip and slide it out from the arm.

i NOTE: Never open the luggage compartment lid when the wiper arms are positioned away from the windscreen. You could damage the luggage compartment lid and/or the wiper arms.

i NOTE: Do not lower the wiper arms onto the windscreen without the wiper blades fitted.

To install a new small wiper blade

1. Slide the wiper blade onto the wiper arm and ensure that the clip engages in the arm.

i NOTE: Ensure the wiper blade is securely fitted in the wiper arm.

2. Lower the wiper arms onto the windscreen.
3. Pull the wiper control stalk towards you once, the wipers will move back to the normal park position.

Maintaining Your McLaren Wheels and Tyres

Wheels and tyres

 **WARNING: Have worn tyres replaced in axle pairs and ensure the tyres are fitted as specified. With worn tyres, the driving stability of the vehicle will be adversely affected, especially when driving at high speeds. Consult your McLaren retailer if you have had new tyres fitted for information on the appropriate bedding in time based on your driving style.**

- With new tyres, avoid high speed cornering and excess speed.
- Only have wheels and tyres of the same type and make fitted.
- Never use a tyre which has been punctured and then repaired.
- Only have tyres of the correct size fitted.
- Tyres degrade over time due to the effects of ultraviolet light, extreme temperatures, high loads, and environmental conditions. It is recommended that tyres are replaced every 6 years, or sooner if required.

McLaren recommend that you only use Pirelli summer or winter tyres, see Wheel and tyre sizes, page 7.12.

These tyres provide the best possible performance in conjunction with the safety systems on your vehicle and have been specifically approved by McLaren.

McLaren cannot accept any responsibility for damage that may result from use of other tyres and wheels. Further information about wheels and tyres can be obtained from your McLaren retailer.

 **WARNING: Using tyres other than those which have been recommended by McLaren, may contact the body work and adversely affect the handling. This may cause loss of vehicle control, resulting in serious personal injury or death. Noise levels and fuel consumption may also be adversely affected. In addition, when driving with a load or when using snow traction devices, they could cause contact between the bodywork and axle components. This could result in damage to the tyres or the vehicle.**

 **NOTE: Retreaded tyres must not be used. Do not fit used tyres if you have no information about their previous usage.**

 **NOTE: Modification to the brake system and wheels is not permitted, nor is the use of spacer plates or brake dust shields. Any such modifications will invalidate the vehicle warranty on the area modified.**

 **NOTE: A wheel change must be carried out at your McLaren retailer. The vehicle could be damaged if it is jacked up incorrectly.**

 **NOTE: Store tyres in a cool, dry place, preferably in the dark. Protect the tyres from oil, grease and petrol.**

Maintaining Your McLaren Wheels and Tyres

Tyre markings



1. Width of tyre in millimetres.
2. Tyre profile given as percentage of tyre width.
3. Indicates that the tyre is radial ply.
4. Indicates the diameter of the wheel rim in inches.
5. The numbers denote load index and the letter indicates the speed rating. 91 indicates a weight of 615 kg (1,350 lbs) and Y indicates speeds over 186 mph (300 km/h).

6. Displays the maximum load which can be carried by the tyre.
7. Treadwear grade number. The higher the figure the longer a tyre will last.
8. The alpha character denotes resistance to heat. An 'A' rated tyre offers most heat resistance.
9. Information about the manufacture of the tyre. Contains place and date of manufacture.

Tyres



WARNING: The tyres must be mounted according to the labelling on the tyre wall. The word 'OUTSIDE' must be on the outer edge of the tyre when it is fitted to the wheel or the stability of the vehicle will be adversely affected, especially at high speeds.

Asymmetric tyres



Asymmetric tyres have a tread pattern that is different from one side of the tread to the other. This combination of tread offers better grip in both wet and dry conditions.

The outer tread features a larger stiffer tread pattern that aids with cornering stability. The inner tread pattern aids stability in wet conditions. A central groove in the tyre aids straight line stability.



WARNING: Only tyres recommended by McLaren are to be fitted to the vehicle.

Maintaining Your McLaren Wheels and Tyres

⚠ WARNING: The tyres must be mounted according to the labelling on the tyre wall. The benefits of asymmetric tyres will only be available if the tyres are fitted correctly.

Trofeo R tyres

The driver's skill level must be commensurate with the vehicle performance levels in the upper range limits due to increased safety risks.

i NOTE: Due to ultra high performance design and the particular manufacturing process of these tyres, they must always be replaced in axle sets (front and rear) regardless of wear or mileage. Failure to do so may have a negative affect on the handling characteristics of the vehicle.

The main features of the Trofeo R tyres are a reduced tread depth and a special tread pattern and carcass compared with other tyres.

⚠ WARNING: Risk of accident from worn tyres. Trofeo R tyres have a smaller tread depth, and thus can reach their wear limit sooner. It is important to check tyre wear frequently to avoid risk of serious personal injury or death from worn tyres.

⚠ WARNING: Risk of accident through loss of road surface contact, control over the vehicle and braking ability, leading to serious personal injury or death. The reduced tyre tread depth means that there is an increased risk of hydroplaning on wet roads. When driving on wet or mud-covered roads reduce speed significantly.

i NOTE: Notify anyone using your car of these characteristics and possible effects.

Inspecting wheels and tyres

At least every 7 days, check the tyres for cuts, punctures, tears, bumps, deformation and cracks. Check wheels for severe corrosion. Damaged wheels could cause a loss of tyre pressure.

Regularly check the tyre tread depth and the condition of the tread across the whole width of the tyre. Turn the front wheels to full lock in order to inspect the inner tread.



When the tread is worn to 1.6 mm, the wear indicators appear on the surface of the tread pattern, producing a continuous band of rubber across the width of the tyre. Tyres must be replaced as soon as the wear indicator becomes visible, or sooner if legislation dictates replacement at a greater tread depth.

Maintaining Your McLaren Wheels and Tyres

i NOTE: It is recommended that you always have your tyres replaced by your McLaren retailer. Each wheel has a tyre pressure sensor connected to the tyre valve. In order to avoid damage to the sensor, the tyres must be replaced using the correct procedure.

! **WARNING: Tyre grip decreases rapidly on wet or icy roads, particularly when the tread depth is close to the minimum. You could lose control of the vehicle and cause an accident due to the reduced grip of the tyres. Reduce your speed and drive with greater care.**

i NOTE: If tread wear is uneven across the tyre, or becomes excessive, the wheel alignment should be checked.

Regularly check the pressure of all your tyres and correct the pressure as necessary, see Cold tyre inflation pressures, page 7.13.

All wheels must have a valve cap fitted to protect the valve against dirt and moisture.

Driving precautions

When parking your McLaren, ensure that the tyres do not contact the kerb or other obstacles. If it is necessary to drive over kerbs, speed humps or potholes, drive slowly and approach the obstacle at a shallow angle or the tyres could be damaged.

While driving, pay attention to vibrations, noises and unusual handling characteristics, e.g. pulling to one side. This may indicate that the tyres or wheels are damaged. If you experience anything unusual, reduce your speed and stop the vehicle as soon as safety permits to check the tyres and wheels for damage. If you find no signs of damage, have the tyres and wheels inspected at your McLaren retailer.

Tyre pressures

! **WARNING: Tyre pressure that is too high or too low has a negative effect on the vehicle's active safety, this could lead to an accident. Frequently check the pressure of all tyres, particularly prior to long trips, and correct the pressure as necessary.**

! **WARNING: If the pressure in a tyre drops repeatedly, inspect the tyre for foreign objects or signs of punctures, check the valve for air leaks.**

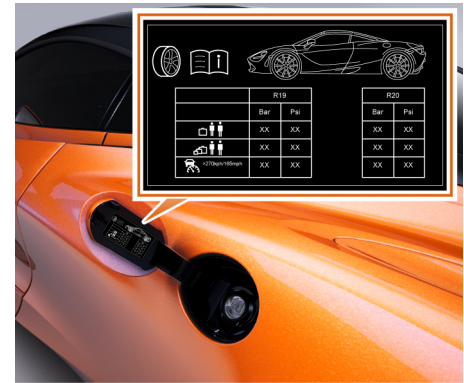

For the tyre pressures for various operating conditions, see Cold tyre inflation pressures, page 7.13. They are also printed on a label attached to the fuel filler flap.

If the vehicle is to be driven at high speeds, the tyre pressure must be checked, and if necessary adjusted.

i NOTE: In some markets, the tyre pressure label is attached to the base of the driver's side door.

Maintaining Your McLaren Wheels and Tyres

 **NOTE:** Tyre pressures given for low loads are minimum values which offer optimum ride comfort. Increased pressures for higher loads will not adversely affect the running of the vehicle, but ride comfort will be impaired.

Check the pressures when the tyres are cold. If it is necessary to check the tyres when they are warm, pressures will be higher. Do not let air out of warm tyres to match the recommended cold tyre pressures.

Driving with tyre pressure that is too high or too low can:

- create a risk of tyre failure with resultant accidents, causing injury or death.
- shorten the life of the tyres.
- cause increased tyre damage.
- have a negative effect on handling characteristics (e.g. by causing aquaplaning).

 **ENVIRONMENTAL:** Check tyre pressures at least every 7 days.

Interchanging wheels



WARNING: Only approved wheels with winter tyres can be fitted to your McLaren as alternatives.

Deflated tyre

Your McLaren is equipped with a container of tyre sealant, which is located in the luggage compartment.

In the event of a puncture, follow the steps below to ensure your safety, and the safety of other vehicle occupants and other road users.

Repairing a puncture

1. Stop the vehicle as far away as possible from traffic and on a firm and level surface.
2. If on a public highway, switch on the hazard warning lamps, see Hazard warning lamps, page 1.53.
3. Apply the parking brake and select neutral.
4. Passengers should exit the vehicle safely and remain well away from the vehicle, the road and any traffic.
5. Place the warning triangle at an appropriate distance from the vehicle to warn other traffic of a breakdown, see Warning triangle, page 6.12.

Maintaining Your McLaren Wheels and Tyres

Using the tyre sealant

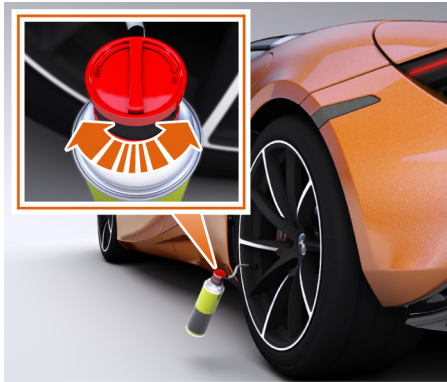

You can use the tyre sealant to seal small punctures, particularly those in the tyre's tread. The tyre sealant can be used at ambient temperatures down to -20°C (-4°F).

⚠ WARNING: The tyre sealant is unable to seal punctures if:

- there are cuts or punctures in the tyre greater than 4 mm.
- the wheel rims are damaged.
- you have driven at very low tyre pressures or with deflated tyres.

Contact your McLaren retailer immediately

Remove the tyre sealant from the luggage compartment and follow the instructions on the container.

i NOTE: If possible, locate the cause of the puncture and position the wheel so the puncture is at the lowest point to enable the sealant to be more effective.

Have the punctured tyre replaced as soon as possible.

⚠ WARNING: Have punctured tyres replaced. McLaren do not recommend that punctured tyres are repaired.

⚠ WARNING: If the tyre sealant comes into contact with your eyes or skin, immediately rinse thoroughly with clean water, change out of clothing which has been in contact with the tyre sealant. If an allergic reaction occurs, contact a doctor immediately.

⚠ WARNING: Keep the tyre sealant out of reach of children. If tyre sealant is swallowed, immediately rinse the mouth thoroughly and drink a large amount of water. Do not induce vomiting. Contact a doctor immediately. Do not inhale tyre sealant fumes.

i NOTE: After using tyre sealant, the tyre valve, incorporating the tyre pressure monitoring system sensor, will have to be replaced.

Maintaining Your McLaren Vehicle Care

Washing your McLaren

 ENVIRONMENTAL: Some cleaning products contain chemicals that are hazardous to the environment. Always take precautions to prevent fluids from spilling and never use excessive quantities.

Hand washing your McLaren

1. Pre-rinse the body thoroughly with a hose pipe held at a shallow angle to loosen any dirt and wet the paintwork ready for washing, avoiding direct spray on engine cover vents.
2. Prepare a bucket of warm water and a good quality car shampoo. Refer to the shampoo manufacturer's instructions for dilution ratios.

3. Working from the top of the vehicle down, wash the vehicle, ideally using a lambswool wash mitt rather than a sponge, use generous quantities of water paying particular attention to areas where dirt can accumulate. Use one wash mitt for the top of the vehicle (roof, luggage compartment lid and areas above the wheel arch line) and a separate mitt for areas below the wheel arch line.

 NOTE: Do not clean the wheels with these wash mitts.

 NOTE: Do not allow the shampoo to dry, it will leave streaks on the paint work.

4. Tar spots and stubborn grease marks can be removed using white spirit or denatured alcohol. After cleaning, immediately wash the area with soapy water to remove all traces of spirit or alcohol.
5. Once the vehicle is clean, work from the top of the vehicle down and rinse thoroughly using a hose pipe held at a shallow angle, avoiding direct spray on engine cover vents.
6. Dry the vehicle using a chamois leather or drying towel.

 NOTE: In case of signs of water in the engine bay, it is advised to drive the vehicle and warm the engine to operating temperature to dry off any excessive water from the engine.

Washing the wheels

 NOTE: Wash the wheels frequently, do not allow brake dust to become ingrained in the wheel rim finish.

Wash the wheels using warm water, a good quality car shampoo and a wheel brush or wash mitt that is used only on the wheels. Apply polish to non-satin finished wheels to assist in keeping them clean.

 NOTE: Never apply polish to satin finish wheels, this will result in localised glossy patches on the surface of the wheel.

 NOTE: Do not use acid based wheel cleaners as these can damage the wheel rim finish leading to corrosion.

 NOTE: Ensure the brakes are fully dried after the wheels have been cleaned before the vehicle is stored.

Maintaining Your McLaren Vehicle Care

Wiper blades and rubber seals

Clean wiper blades and rubber seals using warm water and a good quality car shampoo only. Do not use petroleum or alcohol-based cleaners.

Windscreen, windows and mirrors

Regularly clean all windows inside and out using a window cleaning solution. An automotive glass cleaner is recommended. After washing the vehicle with car shampoo containing wax, clean the outside of the windscreen with glass cleaner. Do not use abrasive cleaning compounds as mirror glass is particularly susceptible to damage.

Underbody cleaning

Salt used on roads to control snow and ice during the winter can collect on the vehicle's underbody, if this is not removed, corrosion can occur. During the winter months, regularly hose the underbody with water paying particular attention to the wheel arches and areas where dirt can accumulate.

Polishing

Occasionally polish the paint work using a good quality polish, following up with a protective wax.

 **NOTE:** Do not use cutting compound, colour restoration products or polishes containing a harsh abrasive. These can scratch the surface and permanently damage the paint work.

Paint damage and rectification

Regularly inspect the paint work for damage. Any stone chips or deep scratches should be repaired as soon as possible. Contact your McLaren retailer for advice.

Cleaning the interior

 **NOTE:** Your McLaren retailer will be able to recommend products for cleaning the interior of your vehicle.

Carpet and fabrics

Before cleaning upholstery, always test the cleaning solution on a concealed area. Clean with diluted upholstery cleaner and a clean cloth.

Leather

Before cleaning leather, always test the cleaning solution on a concealed area. Clean with warm water and a non-detergent soap or a proprietary leather cleaner. Dry with a dry, clean, lint-free cloth. Do not use abrasive cleaning products or polish.

Do not polish the upper surfaces of the dashboard. Polished surfaces are reflective and may interfere with the driver's view. Clean with diluted upholstery cleaner, then wipe with a damp cloth.

Maintaining Your McLaren Vehicle Care

Carbon Fibre

Before cleaning visible carbon fibre, always test the cleaning solution on a concealed area. Clean with a propriety matt dashboard cleaner. Contact your McLaren retailer for more information. Do not use abrasive cleaning products or polish.

Alcantara®

Dust the material with care. Moisten a soft cloth or a sponge with water, wring it thoroughly and run it over the whole Alcantara® material. Make sure not to wet it excessively; rinse the cloth or sponge and repeat as necessary.

Leave the material to dry overnight.

Once the material has dried, in order to restore the material, brush it delicately with a soft bristle brush.

Seat belts

Extend the belts and clean with warm soapy water only. Do not use any type of detergent or chemical cleaning product. Allow the belts to dry naturally while extended, preferably away from direct sunlight.

Instruments and display screens

Clean the Folding Driver Display and Central Infotainment Touchscreen using a damp cloth. Do not use abrasive cleaning products or polish.

Car cover

A car cover, suitable for use inside a garage, can be purchased from your McLaren retailer.

McLaren recommend that the vehicle is covered if it is to be left in storage for periods over two weeks. Clean the vehicle inside and out, ensuring that it has fully dried, prior to fitting the cover.



NOTE: Allow the engine to cool before fitting the cover or the hot exhaust pipes could cause damage to the cover.

Maintaining Your McLaren

Raising the Vehicle

Vehicle lifting points

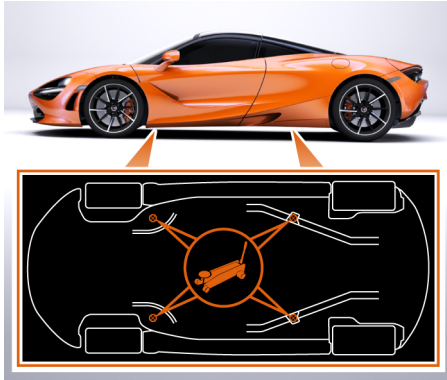

Refer to the illustration, and labels on the vehicle, for correct lifting locations.

Make this information available to any third parties who may be assisting in the recovery of your McLaren.

i NOTE: Lifting the vehicle at any other points will damage the vehicle.

i NOTE: Use a jack with a flat lifting platform and a rubber pad to protect the chassis from surface damage. Do not lift under a body panel.

⚠ **WARNING:** Ensure the vehicle is correctly positioned on a jack or vehicle lift before raising the vehicle to a workable height. Always engage vehicle lift safety locks or use suitable stands to ensure your safety before working under the vehicle.

Maintaining Your McLaren

McLaren Assistance

McLaren assistance

If your McLaren is immobilised, do not attempt to make your own arrangements for assistance. Refer to your Service and Warranty Guide, this contains all the information you need.

Replacement battery

If your McLaren has been immobilised due to a fault with the vehicle battery, the battery must only be replaced with a lithium-ion battery of the correct specification.

In the event of a breakdown

In the event of a problem with your vehicle, contact your McLaren retailer. If your McLaren retailer is unavailable, contact the roadside assistance operator who is available 24 hours a day, 7 days a week.



NOTE: The contact details of your roadside assistance operator can be found in your Service and Warranty Guide.

The McLaren retailer or roadside assistance operator will verify your identity and that of your vehicle, as well as determining your exact location.

They will then discuss the problem with you and, with your agreement, determine the best solution.

Maintaining Your McLaren

McLaren Assistance

Towing for recovery

Your McLaren is equipped with a front towing eye mounting only.

- i** NOTE: Do not tow the vehicle, doing so could damage the gearbox. The towing eye must only be used to winch the vehicle onto a trailer or transporter for recovery purposes. Do not use a rigid bar to tow the vehicle.

Towing eye and mounting

1. Remove the cover from the towing eye mounting in the front bumper.

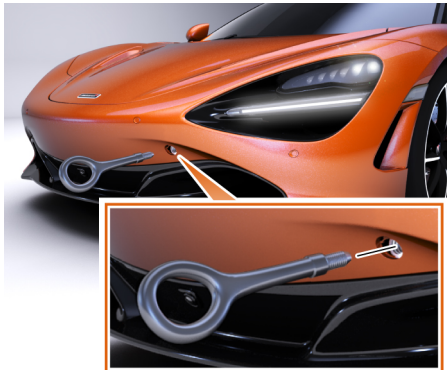

2. Screw the towing eye clockwise into the mounting hole, ensuring that it is screwed in to the full extent of the thread.

- i** NOTE: To avoid damage to the towing eye and the vehicle, it is important to ensure that the towing eye is in full contact with the mating surface of the front structure.

- i** NOTE: A winch cable/strap must be secured to the towing eye only or the vehicle could be damaged.

3. Remove the towing eye, stow it in the luggage compartment and refit the cover to the towing eye mounting as soon as the vehicle has been recovered.

Maintaining Your McLaren Driving Abroad

Driving abroad

McLaren retailers are also at your disposal when you are travelling abroad.

The legal requirements when driving abroad vary from country to country and are constantly changing. Always seek advice from your McLaren retailer regarding what is required to remain legal in the countries in which you are travelling.

In certain countries, only low-octane fuel is available. For further information about fuel grades, see Recommended fuel, page 2.50.

-  **NOTE:** The headlamp asymmetric dipped beam is designed to light up the near side of the road more intensely. On your McLaren, the same headlamp dipped beam setting applies for driving on either the left-hand or right-hand side of the road.

McLaren 

Vehicle Data and Glossary

Genuine McLaren Parts and Accessories.....	7.02
Overview.....	7.02
Vehicle Identification.....	7.03
Vehicle identification number (VIN).....	7.03
Data.....	7.04
Overview.....	7.04
Vehicle operating temperatures.....	7.04
Engine.....	7.04
Maximum speeds in each gear.....	7.06
Gear ratios.....	7.06
Vehicle dimensions.....	7.07
Vehicle weights.....	7.10
Wheel and tyre sizes.....	7.12
Turning circle.....	7.13
Cold tyre inflation pressures.....	7.13
Service Products, Fluids and Capacities.....	7.15
Service products.....	7.15
Engine oil specification.....	7.15
Fuel.....	7.15
Coolant.....	7.16
Power steering fluid.....	7.16
Brake fluid.....	7.17
Technical Glossary.....	7.18
Technical glossary.....	7.18

Vehicle Data and Glossary

Genuine McLaren Parts and Accessories

Overview

McLaren recommend that you only use genuine McLaren replacement parts and accessories. The use of non-genuine parts could have a detrimental effect on the vehicle's operation and safety. McLaren tests replacement parts and accessories, for reliability, safety and suitability. McLaren accepts no responsibility for the use of non-genuine parts on their vehicles, even if they have been independently approved.

In many countries, replacement parts and accessories are only officially approved for installation if they comply with legal requirements. All genuine McLaren replacement parts and accessories meet these requirements.

Genuine McLaren parts and accessories can be obtained from your McLaren retailer where the parts will be professionally fitted.

Ensure that any accessories are suitable for your McLaren. Accessories which constitute a modification to the vehicle could invalidate the vehicle's warranty. This applies if they:

- change the vehicle type approved in the warranty.
- could endanger road users.

- adversely affect the vehicle's emissions and noise levels.

Always quote the vehicle identification number, you will find this on the vehicle identification plate, and in the bottom left-hand corner of the windscreen.

Vehicle Data and Glossary

Vehicle Identification

Vehicle identification number (VIN)



The vehicle identification number can be found on the bottom left-hand corner of the windscreen.

The number can also be found engraved on the body behind the right-hand seat, stamped on a plate at the base of the driver's side door aperture and viewed in the Vehicle info section on the Folding Driver Display, see Vehicle identification, page 3.09.

VIN plate



The vehicle identification number plate also contains the following:

- Maximum permitted laden weight
- Maximum permitted laden weight including trailer
- Maximum permitted front axle laden weight
- Maximum permitted rear axle laden weight

Vehicle Data and Glossary Data

Overview

This section contains all the necessary technical data for your vehicle and applies to the vehicle's standard equipment. The data may therefore differ for vehicles with optional equipment. You can obtain further information from your McLaren retailer.

Vehicle operating temperatures

Minimum ambient operating temperature	-20°C (-4°F)
Maximum ambient operating temperature	+50°C (+122°F)

i NOTE: If the vehicle is used outside the minimum and maximum ambient temperatures, performance degradation may be experienced. McLaren disclaims any liability of the stated engine power not being achieved if the vehicle is being used outside of the stated temperature ranges or being used at altitude.

Engine

Engine - 720S Coupe	
Rated output (kW) @rpm	537 @ 7,500
Rated output (PS) @rpm	720 @ 7,500
Rated torque (Nm) @rpm	770 @ 5,500
Rated torque (lb-ft) @rpm	568 @ 5,500
Number of cylinders	8
Displacement cm ³	3,994
Maximum engine speed (rpm)	8,500
Power to weight ratio (PS/tonne)	561

Vehicle Data and Glossary

Data

Engine - 720S Spider	
Rated output (kW) @rpm	530 @ 7,250
Rated output (PS) @rpm	720 @ 7,250
Rated torque (Nm) @rpm	770 @ 6,500
Rated torque (lb-ft) @rpm	568 @ 6,500
Number of cylinders	8
Displacement cm ³	3,994
Maximum engine speed (rpm)	8,500
Power to weight ratio (PS/tonne)	540

Engine - 765LT Coupe	
Rated output (kW) @rpm	563 @ 7,500
Rated output (PS) @rpm	765 @ 7,500
Rated torque (Nm) @rpm	800 @ 5,500
Rated torque (lb-ft) @rpm	590 @ 5,500
Number of cylinders	8
Displacement cm ³	3,994
Maximum engine speed (rpm)	8,500
Power to weight ratio (PS/tonne)	615

Engine - 765LT Spider	
Rated output (kW) @rpm	563 @ 7,500
Rated output (PS) @rpm	765 @ 7,500
Rated torque (Nm) @rpm	800 @ 5,500
Rated torque (lb-ft) @rpm	590 @ 5,500
Number of cylinders	8
Displacement cm ³	3,994
Maximum engine speed (rpm)	8,500
Power to weight ratio (PS/tonne)	592

Vehicle Data and Glossary Data

Maximum speeds in each gear

720S Coupe and Spider	
1st gear (mph (km/h))	50 (80)
2nd gear (mph (km/h))	76 (122)
3rd gear (mph (km/h))	105 (169)
4th gear (mph (km/h))	136 (218)
5th gear (mph (km/h))	173 (278)
6th gear (mph (km/h))	212 (340)
7th gear (mph (km/h))	197 (317)

765LT Coupe and Spider	
1st gear (mph (km/h))	44 (71)
2nd gear (mph (km/h))	67 (108)
3rd gear (mph (km/h))	93 (150)
4th gear (mph (km/h))	120 (193)

5th gear (mph (km/h))	153 (246)
6th gear (mph (km/h))	195 (314)
7th gear (mph (km/h))	205 (330)

Gear ratios

Gear ratios - 720S Coupe and Spider	
1st gear	3.982:1
2nd gear	2.612:1
3rd gear	1.905:1
4th gear	1.479:1
5th gear	1.160:1
6th gear	0.906:1
7th gear	0.686:1
Final drive	3.308:1

Gear ratios - 765LT Coupe and Spider	
1st gear	3.982:1
2nd gear	2.612:1
3rd gear	1.905:1

Vehicle Data and Glossary Data

4th gear	1.479:1
5th gear	1.160:1
6th gear	0.906:1
7th gear	0.686:1
Final drive	3.727:1

Vehicle dimensions

Dimensions - 720S Coupe and Spider

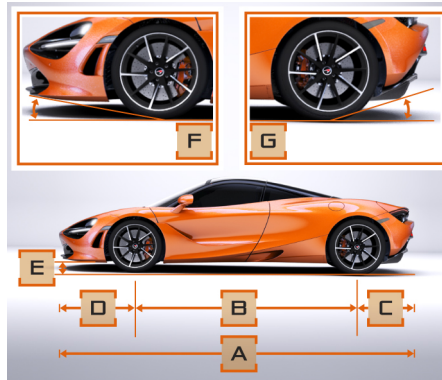

A	Vehicle length	4,543 mm (14 ft 11 in)
B	Wheelbase	2,670 mm (8 ft 10 in)
C	Rear overhang	816 mm (2 ft 8 in)
D	Front overhang	1,058 mm (3 ft 6 in)

E	Ground clearance (normal)	107 mm (4 in)
	Ground clearance (vehicle lift)	134 mm (5 in)
F	Approach angle (normal)	8.3°
	Approach angle (vehicle lift)	10.4°
G	Departure angle (normal)	13.3°
	Departure angle (vehicle lift)	12.6°

Vehicle Data and Glossary Data

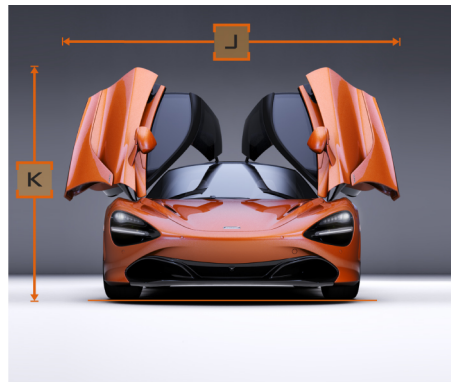

H	Vehicle width (doors closed, including mirrors)	2,161 mm (7 ft 1 in)
I	Vehicle height (doors closed) - Coupe	1,196 mm (3 ft 11 in)
	Vehicle height (doors closed) - Spider	1,194 mm (3 ft 11 in)

J	Vehicle width (doors open at widest point)	2,809 mm (9 ft 3 in)
K	Vehicle height (doors open)	1,953 mm (6 ft 5 in)

i NOTE: All dimensions are approximate.

Dimensions - 765LT Coupe and Spider

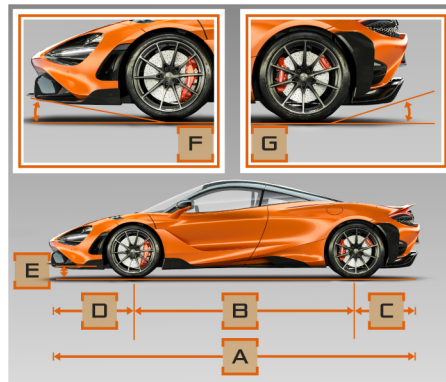

A	Vehicle length	4,600 mm (15 ft 1 in)
B	Wheelbase	2,670 mm (8 ft 10 in)
C	Rear overhang	824 mm (2 ft 8 in)
D	Front overhang	1,105 mm (3 ft 8 in)
E	Ground clearance (normal)	101 mm (4 in)
	Ground clearance (vehicle lift)	106 mm (4 in)

Vehicle Data and Glossary Data

F	Approach angle (normal)	6.93°
	Approach angle (vehicle lift)	8.88°
G	Departure angle (normal)	12.3°

H	Vehicle width (doors closed, including mirrors)	2,161 mm (7 ft 1 in)
I	Vehicle height (doors closed) - Coupe	1,159 mm (3 ft 10 in)

J	Vehicle width (doors open at widest point)	2,767 mm (9 ft 1 in) 675LT Coupe
		3,006 mm (9 ft 10 in) 675LT Spider
K	Vehicle height (doors open)	1,947 mm (6 ft 5 in) 675LT Coupe
		1,960 mm (6 ft 5 in) 675LT Spider

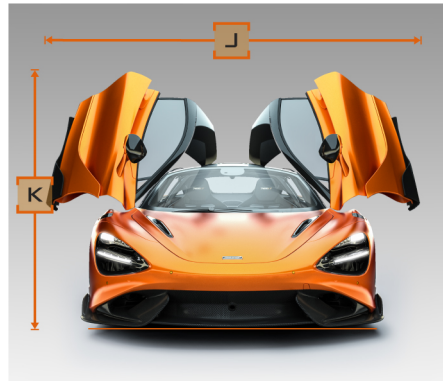
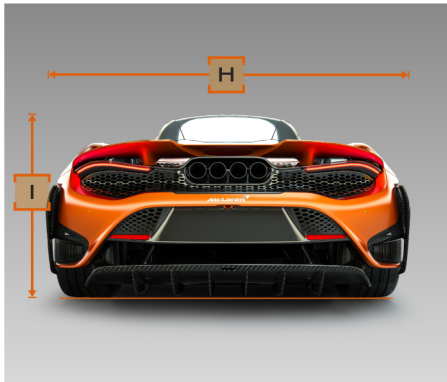

i NOTE: All dimensions are approximate.

Vehicle Data and Glossary Data

Vehicle weights

Weight - 720S Coupe	
Dry weight (kg (lbs))	1,322 (2,920)
Unladen weight (all fluids and 90% fuel) (kg (lbs))	1,419 (3,128)
Kerb weight (plus 75 kg driver) (kg (lbs))	1,494 (3,294)
Kerb weight distribution (plus 75 kg driver) - front axle (kg (lbs))	621 (1,368)
Kerb weight distribution (plus 75 kg driver) - rear axle (kg (lbs))	873 (1,925)
Maximum gross vehicle weight (GVW) (kg (lbs))	1,690 (3,727)

Maximum gross vehicle weight distribution - front axle (kg (lbs))	763 (1,682)
Maximum gross vehicle weight distribution - rear axle (kg (lbs))	928 (2,045)
Maximum load - front luggage compartment (kg (lbs))	50 (110)

Weight - 720S Spider	
Dry weight (kg (lbs))	1,371 (3,022)
Unladen weight (all fluids and 90% fuel) (kg (lbs))	1,468 (3,236)
Kerb weight (plus 75 kg driver) (kg (lbs))	1,543 (3,402)

Kerb weight distribution (plus 75 kg driver) - front axle (kg (lbs))	658 (1,451)
Kerb weight distribution (plus 75 kg driver) - rear axle (kg (lbs))	885 (1,951)
Maximum gross vehicle weight (GVW) (kg (lbs))	1,741 (3,838)
Maximum gross vehicle weight distribution - front axle (kg (lbs))	807 (1,779)
Maximum gross vehicle weight distribution - rear axle (kg (lbs))	934 (2,059)

Vehicle Data and Glossary Data

Maximum load - front luggage compartment (kg (lbs))	50 (110)
---	----------

Weight - 765LT Coupe	
Dry weight (kg (lbs))	1,243 (2,740)
Unladen weight (all fluids and 90% fuel) (kg (lbs))	1,339 (2,952)
Kerb weight (plus 75 kg driver) (kg (lbs))	1,414 (3,117)
Kerb weight distribution (plus 75 kg driver) - front axle (kg (lbs))	594 (1,310)
Kerb weight distribution (plus 75 kg driver) - rear axle (kg (lbs))	820 (1,808)

Maximum gross vehicle weight (GVW) (kg (lbs))	1,644 (3,624)
Maximum gross vehicle weight distribution - front axle (kg (lbs))	751 (1,656)
Maximum gross vehicle weight distribution - rear axle (kg (lbs))	893 (1,748)
Maximum load - front luggage compartment (kg (lbs))	50 (110)

Weight - 765LT Spider	
Dry weight (kg (lbs))	1,292 (2,848)
Unladen weight (all fluids and 90% fuel) (kg (lbs))	1,388 (3,060)

Kerb weight (plus 75 kg driver) (kg (lbs))	1,463 (3,225)
Kerb weight distribution (plus 75 kg driver) - front axle (kg (lbs))	609 (1,343)
Kerb weight distribution (plus 75 kg driver) - rear axle (kg (lbs))	854 (1,883)
Maximum gross vehicle weight (GVW) (kg (lbs))	1,690 (3,726)
Maximum gross vehicle weight distribution - front axle (kg (lbs))	765 (1,687)
Maximum gross vehicle weight distribution - rear axle (kg (lbs))	925 (2,039)

Vehicle Data and Glossary Data

Maximum load - front luggage compartment (kg (lbs))	50 (110)
---	----------

Wheel and tyre sizes

Wheel sizes

Front wheels	9J x 19
Rear wheels	11J x 20

Summer tyres

Front tyres	
- Pirelli P Zero™ MC1	245/35 R19
- Pirelli P Zero™ Corsa MC1	245/35 R19
- Pirelli P Zero™ Trofeo R MC2	245/35 R19

Rear tyres	
- Pirelli P Zero™ MC1	305/30 R20
- Pirelli P Zero™ Corsa MC1	305/30 R20
- Pirelli P Zero™ Trofeo R MC2	305/30 R20

Vehicle Data and Glossary Data

Winter tyres

Front tyres	
- Pirelli SottoZero™ 2	245/35 R19

Rear tyres	
- Pirelli SottoZero™ 2	295/30 R20

Turning circle

Turning circle kerb-to-kerb	12.2 m (40 ft)
--------------------------------	----------------

Cold tyre inflation pressures

Loading condition	Front wheels		Rear wheels	
	Bar	Psi	Bar	Psi
Normal use				
Pirelli P Zero™	2.2	32	2.2	32
Pirelli P Zero™ Corsa	2.2	32	2.2	32
Pirelli SottoZero™	2.2	32	2.2	32
Pirelli P Zero™ Trofeo R	2.0	29	2.0	29

Loading condition	Front wheels		Rear wheels	
	Bar	Psi	Bar	Psi
Speeds over 165 mph (270 km/h)				
Pirelli P Zero™	2.7	39	2.7	39
Pirelli P Zero™ Corsa	2.7	39	2.7	39

Vehicle Data and Glossary Data

Loading condition	Front wheels		Rear wheels	
	2.5	36	2.5	36
Pirelli P Zero™ Trofeo R				

The tyre pressures can also be found on a label on the inside of the fuel filler flap.

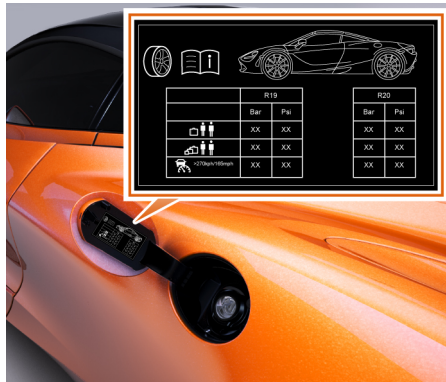

i NOTE: In some markets, the tyre pressure label is attached to the base of the driver's side door aperture.

Vehicle Data and Glossary

Service Products, Fluids and Capacities

Service products

Service products are fuel, engine oil, coolant and brake fluid. McLaren recommend that you only use products tested and approved for McLaren. Damage resulting from using non-approved service products is not covered by the liability for material defects.

 **WARNING: When handling, storing and disposing of any service products, please observe the relevant regulations. Failure to do so could endanger people and the environment. Do not allow service products to come into direct contact with your eyes or open wounds. Contact a doctor immediately if any service product is swallowed.**

 **ENVIRONMENTAL:** Dispose of service products in an environmentally responsible manner.

Engine oil specification

Engine oil capacity	8.0 litres
---------------------	------------

 **NOTE:** McLaren recommend only Gulf 5W-40 engine oil.

You may obtain further information from your McLaren retailer.

 **NOTE:** Do not use any lubricant additives. These could lead to increased wear and damage to the mechanical assemblies. Damage caused by additives, which are not approved, is not covered by the McLaren warranty.

Fuel

 **WARNING: Fuel is highly flammable. Fire, naked flames and smoking are prohibited when handling fuels. Switch off the engine before refuelling.**

 **WARNING: Do not allow fuel to come into contact with skin or clothing. Allowing fuels to come into direct contact with your skin or inhaling fuel vapours is damaging to your health.**

For more information about fuel, see Recommended fuel, page 2.50.

Fuel tank

Total capacity	60 litres (13.2 UK gal.)
Capacity remaining when amber low level lamp illuminates	20 litres (4.4 UK gal.)
Capacity remaining when red low level lamp illuminates	11 litres (2.4 UK gal.)

Vehicle Data and Glossary

Service Products, Fluids and Capacities

Coolant

Cooling system capacity	24.5 litres (5.4 UK gal.)
Antifreeze quantity for protection to -20°C (-4°F)	12.25 litres (2.7 UK gal.)

The coolant is a mixture of water, antifreeze and corrosion inhibitor. It performs the following functions in the cooling system:

- Antifreeze protection
- Increased efficiency of the cooling system
- Offers anti-corrosion protection

 **NOTE:** Use coolant in all climates, all year round. If coolant is not used, the cooling system will not be sufficiently protected from corrosion and the cooling system efficiency will be reduced.

 **NOTE:** To prevent damage to the engine, only top up with a pre-mixed coolant that provides the desired level of antifreeze protection.

If antifreeze/corrosion inhibitor is present in the correct concentration, the boiling point of the coolant will be around 130°C (266°F). The antifreeze and corrosion inhibitor concentration in the cooling system should be approximately 50% ±5%. This will protect the cooling system against freezing in temperatures of -40°C (-40°F).

The antifreeze and corrosion inhibitor concentration in the cooling system should not exceed 55%, which provides antifreeze protection down to -45°C (-49°F), as a higher concentration will not dissipate heat as effectively.

If the vehicle is losing coolant, do not drive your vehicle and contact your McLaren retailer.

Power steering fluid

Only use Pentosin CHF202 power steering fluid.

Vehicle Data and Glossary

Service Products, Fluids and Capacities

Brake fluid

Only use Pentosin DoT 5.1 brake fluid.

Over time, the brake fluid absorbs moisture from the air, this reduces its boiling point.



WARNING: If the boiling point of the brake fluid is reduced too much, vapour pockets may form in the brake system when the brakes are applied hard (e.g. when driving downhill or track driving) impairing the braking efficiency. Therefore, the brake fluid must be replaced at the recommended service intervals.

Vehicle Data and Glossary

Technical Glossary

Technical glossary

Active dynamics control

A system that allows the driver to change the handling and performance characteristics of the vehicle.

Airbrake

The Airbrake is a moveable wing that enhances the vehicle's driving stability and braking performance by increasing rear downforce.

Anti-lock braking system (ABS)

The ABS prevents the wheels from locking when you brake. This allows the vehicle to be steered during braking manoeuvres.

Automatic driver recognition cards

A card which must be on the person entering the vehicle or the tracker system signals that the vehicle is being moved without authorisation.

Brake assist system

The brake assist system operates in emergency braking situations. If you depress the brake pedal quickly, the brake assist system automatically increases the force being applied to the brakes and thus shortens the stopping distance.

Brake disc wiping

Brake disc wiping operates when the windscreen wipers are switched on. It prevents moisture build up on the brake discs during periods of heavy rain, by applying the brakes momentarily, so that the pads touch the discs.

Brake steer

Brake steer offers the benefits of a torque vectoring differential, but is integrated into the braking system reducing weight and providing excellent speed of response.

If the system detects that the vehicle is starting to understeer through a corner, the inside rear brake is gently applied. This helps to increase the yaw rate of the vehicle, making the vehicle feel more resistant to understeer. The lateral 'g' force is also increased giving better handling characteristics.

If the driver uses too much throttle exiting a corner, the inside rear wheel increases speed, which without brake steer could cause the vehicle to become unstable. In this situation, brake steer will again gently apply the brake on the inside rear wheel, thereby restoring traction and stability.

Cylinder cut

Cylinder cut operates during automatic upshifts in Sport and Track powertrain modes and manual upshifts in Comfort powertrain mode.

When calling for an upshift under hard acceleration, fuel is interrupted (cut) in a defined number of engine cylinders. This rapidly decrease the engine torque and engine speed, allowing faster upshifts to be achieved. This will make the upshift more audibly noticeable than a normal upshift.

Electronic brake pre-fill

If the accelerator pedal is suddenly released, the electronic brake pre-fill function immediately brings the brake pads into contact with the discs, enabling more rapid braking.

Electronic stability control (ESC)

ESC monitors driving stability and traction between the tyres and the road surface.

Vehicle Data and Glossary

Technical Glossary

Global positioning system (GPS)

By means of the appropriate receivers, satellite signals supply information on the geographical position of the vehicle. These signals are compared with a digital map and used both to determine the position of the vehicle and for its route guidance.

Handling control

The handling control switch affects the Proactive Chassis Control II system.

Hill hold control

Hill hold control prevents roll-back on hill starts. The brake system automatically applies the brakes until the accelerator is pressed.

Ignition cut

Ignition cut operates during manual upshifts in powertrain mode.

When calling for an upshift under hard acceleration, ignition is interrupted (cut) in a defined number of engine cylinders. This rapidly decreases the engine torque and engine speed, allowing faster upshifts to be achieved.

Inertia push

When Non-Active is selected or within Track powertrain mode when calling for an upshift at high engine speeds under hard acceleration, inertia push delivers greater acceleration. Under normal driving conditions, outside of inertia push when maximum performance is not called for, the engine and transmission speeds are aligned for a smooth seamless upshift. However, with inertia push, the clutch holding the next gear is engaged with greater force and the engine speed is not allowed to decrease fully, therefore utilising the inertia of its internal rotating masses. This in turn provides a torque impulse as the gear is engaged aiding acceleration and maximising performance.

Keyless entry

Keyless entry allows the driver to unlock the vehicle and disarm the alarm by simply opening the door when the key fob is within 1.2 m (3 ft 11 in) of the door sensors.

Launch control

Launch control is designed to give the maximum acceleration performance from a standing start.

Motorway function lighting

The motorway function lighting improves the headlamp illumination range when the vehicle speed exceeds a predetermined threshold.

Parking sensors

The parking sensor system comprises four ultrasonic sensors in the front bumper, four ultrasonic sensors in the rear bumper and two sounders. When the parking sensors detect an obstruction while manoeuvring, the sounders provide an audible warning.

Performance shift cue (PSC)

PSC is an audible shift indicator, which will sound to indicate that an upshift is required to maintain optimum performance.

Rear view camera (RVC)

The RVC is mounted in the centre of the rear bumper. The live video feed is displayed on either the Folding Driver Display or the Central Infotainment Touchscreen when the function is active.

Vehicle Data and Glossary

Technical Glossary

Seamless shift gearbox

The seamless shift gearbox is a 7 speed, dual clutch gearbox. Gear changes can be fully automatic or driver controlled. The gear changes are almost instantaneous. It is this coupled with uninterrupted torque delivery from the engine which provides the relentless acceleration.

Static Adaptive Headlamps

With the headlamps on, the Static Adaptive Headlamps adjust the beams when cornering, providing improved illumination in the direction of travel.

Supplementary restraint system (SRS)

The SRS comprises a number of air bags which are automatically deployed in an accident to provide additional occupant protection.

360 Park Assist

The system uses four cameras, mounted in the centre of the rear bumper, front bumper and each exterior mirror. The live video feed from each camera creates the surround view displayed on the Central Infotainment Touchscreen when the function is active.

Tyre pressure monitoring system (TPMS)

The TPMS constantly checks the pressure and temperature in all four tyres. It warns if the pressure drops or the temperature rises in one or more of the tyres.

Vehicle identification number (VIN)

The VIN is a unique 17 digit number which provides information about your vehicle, as well as when and where it was built.

Typical VIN = SBM14DCC1HW000001

McLaren 

Conformity Information

Compliance	8.02
McLaren Infotainment System (MIS).....	8.02
Smart Key Fob.....	8.03

Conformity Information Compliance

McLaren Infotainment System (MIS)

All regions/markets

Model: ECI1-MC100E, ECI1-MC100J, ECI1-MC100K,
ECI1-MC100M

Speaker Impedance: 4-8Ω

Operating Voltage: 14.2V (9V - 16V allowable)

Cambodia

0030-2017-100M

India

ETA-1155/2017/ERLO

Indonesia

50203/SDPPI/2017

2354

Philippines



NTC

Type Accepted

No. ESD-1714361C

Singapore

Complies with IMDA standards DB102150

Taiwan



CCAL17LP0410T9

國家通訊傳播委員會(NCC)警告聲明

低功率電波輻射性電機管理辦法

第十二條

經型式認證合格之低功率射頻電機，非經許可，公司、商號或使用者均不得擅自變更頻率、加大功率或變更原設計之特性及功能。

得擅自變更頻率、加大功率或變更原設計之特性及功能。

第十四條

低功率射頻電機之使用不得影響飛航安全及干擾合法通信；經發現有干擾現象時，應立即停用，並改善至無干擾時方得繼續使用。

前項合法通信，指依電信法規定作業之無線電通信。

低功率射頻電機須忍受合法通信或工業、科學及醫療用電波輻射性電機設備之干擾。



Conformity Information Compliance

Smart Key Fob

操作電壓 12 V
(9 V 至 16 V 容限)

這些規格在 14.2V 下測量。

McLaren 

Index

3

360 Park Assist.....2.15

A

Accelerator pedal position.....2.17

Accessories

overview.....7.02

Active dynamics panel.....2.21

active button.....2.21

handling control.....2.22

launch control.....2.26

powertrain control.....2.24

Active speed limiter

setting an upper speed limit.....2.45, 2.46

Air bags.....1.39

child passengers.....1.43

deployment.....1.42

front air bags.....1.39

occupant classification system.....1.40

Out Of Position (OOP) testing.....1.42

replacement.....1.39

side head air bags.....1.40

system modification.....1.39

Airbrake.....2.34

manual test.....2.37

Air distribution - climate control.....5.09

Air recirculation mode - climate

control.....5.08

Air vents

central dashboard.....5.10

dashboard.....5.10

Alarm.....1.24

arming.....1.24

disarming.....1.24

panic.....1.54

Anti-lock braking System.....2.29

Anti-trap protection - windows.....5.03

Auto alarm.....4.19

Automatic door locking.....4.19

Automatic light control.....1.50

Automatic locking.....1.11

Automatic mirror folding.....4.19

Automatic mode - climate control.....5.05

Automatic mode - transmission.....2.18

Automatic wipe.....1.55

B

Backlight.....1.19

closing.....1.20

opening.....1.20

operation.....1.19

Battery.....6.16

Battery Care And Maintenance

battery charging.....6.16

charging the battery.....6.16

Battery fuse box.....6.24

fuses.....6.24

Battery replacement - key fob.....6.32

Battery safety.....6.16

Battery status.....3.08

Belts - seat.....1.37

Blower speed - climate control.....5.09

Bluetooth phone settings.....4.16

Boost starting.....6.17

Brake assist system.....2.30

Brake disc wiping.....2.30

Brake fluid.....7.17

topping up.....6.10

Brake pedal.....2.08

Brakes

Anti-lock Braking System.....2.29

Anti-lock Braking System warning

light.....2.30

bedding-in.....2.47

brake assist system.....2.30

brake disc wiping.....2.30

brake steer.....2.31

electronic brake pre-fill.....2.31

foot.....2.08

hill hold control.....2.31

parking.....2.06

pedal.....2.08

warning light.....2.08

Index

Brake-steer.....	2.31
Breakdown.....	6.45
Bulb replacement.....	6.26

C

Camera.....	2.14
360 Park Assist.....	2.15
rear view.....	2.14
surround view.....	2.15
Cameras.....	4.24
Capacities.....	7.15
cooling system.....	7.16
engine oil.....	7.15
fuel tank.....	7.15
Car cover.....	6.43
Catalytic converter.....	2.12
high temperature.....	2.12
Central Display	
AUX.....	4.36
bluetooth audio.....	4.36
bluetooth phone settings.....	4.16
cameras.....	4.24
connecting an external device.....	4.34
connection settings.....	4.13
contacts.....	4.30
copyright.....	4.04
device pairing.....	4.26
ending a call.....	4.30

garage door opener.....	4.24, 4.49
general settings.....	4.08
in-call options.....	4.30
introduction.....	4.06
light settings.....	4.16
making a call.....	4.28
McLaren Track Telemetry.....	4.43
media controls.....	4.33
navigation.....	4.22
other information.....	4.04
overview - media.....	4.32
overview - navigation.....	4.37
overview - phone.....	4.25
overview - radio.....	4.41
radio & media settings.....	4.15
radio controls.....	4.41
radio data system.....	4.42
receiving a call.....	4.29
regional settings.....	4.10
safety.....	4.37
setting a destination.....	4.39
settings.....	4.08
sound settings.....	4.14
storage.....	4.35
system controls.....	4.04
USB and iPod.....	4.34
using navigation.....	4.38
voice recognition.....	4.51

Centre console stowage	
compartment.....	5.14, 5.15
Changing wheels.....	6.39
Checking engine oil.....	6.04
Child passengers.....	1.43
Child restraint system.....	1.43
KISI child seat function.....	1.44
Cleaning.....	6.41
Centre Display.....	6.43
Driver Display.....	6.43
exterior.....	6.41
instruments and display screens.....	6.43
interior.....	6.42
wheels.....	6.41
Climate control.....	5.04
air conditioning controls.....	5.04
air distribution.....	5.09
air recirculation mode.....	5.08
air vents.....	5.10
automatic mode.....	5.05
blower speed.....	5.09
central air vent.....	5.10
controls.....	5.04
demisting.....	5.07
heated mirrors.....	5.11
heated rear window.....	5.11
heated seats.....	5.10
Hot Evac.....	5.06
manual mode.....	5.05

Index

switching on/off.....	5.06	resuming speed.....	2.44	track mode.....	3.18
SYNC mode.....	5.05	setting.....	2.41	trip computer.....	3.06
temperature.....	5.07	Cup holders.....	5.16	vehicle info.....	3.07
Clock.....	3.04	D		water temperature.....	3.20
Closing the backlight.....	1.20	D		Display messages.....	3.11
Closing the luggage compartment.....	1.14	Data		Display screen cleaning.....	6.43
Closing the roof.....	1.17	overview.....	7.04	Door mirror heating.....	1.47
Closing the roof with the key fob.....	1.18	Daytime running lamps.....	1.52	Doors	
Closing the tonneau cover.....	1.21	Defrosting - climate control.....	5.07	automatic locking.....	1.11
Closing the windows.....	5.02	Demisting - climate control.....	5.07	closing.....	1.10
Compliance		Deployment - air bags.....	1.42	locking.....	1.07
McLaren Infotainment System		Dimensions.....	7.07	locking and unlocking from inside.....	1.09
(MIS).....	8.02	Dipped beam headlamps.....	1.50	manual opening from inside.....	6.29
Conformity Information		Direction indicators.....	1.53	opening from inside.....	1.09
McLaren Infotainment System		Discharged battery.....	1.06	opening from inside - discharged	
(MIS).....	8.02	Discharged key fob battery.....	6.32	battery.....	6.29
Connection settings		starting the engine.....	6.28	opening from outside.....	1.06
overview.....	4.13	unlocking.....	6.27	battery.....	6.27
Coolant.....	7.16	Display.....	3.18	stowage compartment.....	5.15
topping up - Coupe.....	6.07	Electronic Stability Control display.....	3.19	Door stowage compartments.....	5.15
topping up - Spider.....	6.07	fuel level.....	3.21	Door unlock.....	4.20
Copyright.....	3, 4.04	fuel range.....	3.21	Drink holders.....	5.16
Cover - service.....	1.11, 1.13	gear position indicator.....	3.19	Driver Display.....	3.04, 3.18
Installation.....	1.12, 1.13	handling and powertrain display.....	3.19	Comfort mode.....	3.18
Removal.....	1.11, 1.13	instruments cluster.....	3.04	fuel level.....	3.21
Cruise control.....	2.41	messages.....	3.11	gear position indicator.....	3.19
cancelling.....	2.42	oil temperature.....	3.20	left-hand display overview.....	2.05
decreasing speed.....	2.43	sport mode.....	3.18	media.....	3.10
increasing speed.....	2.43				

Index

messages.....	3.11	Eco Start-Stop System.....	2.09	stopping.....	2.09
navigation.....	3.10	Electrical status.....	2.02	technical data.....	7.04
overview.....	3.02	Electric seats.....	1.29	warning light.....	2.11
phone.....	3.09	backrest rake adjustment.....	1.30	Engine oil.....	6.04
right-hand display overview.....	2.06	forward and rearward adjustment.....	1.29	capacity.....	7.15
shift lights.....	3.02	height adjustment.....	1.30	checking.....	6.04
speedometer.....	3.03	lumbar adjustment.....	1.31	level warnings.....	6.04
sport mode.....	3.18	Electric seats and mirror memory.....	1.31	specification.....	7.15
tachometer.....	3.02	Electric Windows		temperature warnings.....	6.06
track mode.....	3.18	Safety.....	5.02	topping up.....	6.05
trip computer.....	3.06	Electrochromic Roof.....	5.13	usage.....	6.04
vehicle info.....	3.07	Electronic brake pre-fill.....	2.31	Entry lighting.....	5.13
water temperature.....	3.20	Electronic Stability Control.....	2.32	Equipment.....	6.12
Driver Display deployment.....	3.04	deactivating.....	2.32	luggage compartment.....	6.12
Driver Display folding.....	3.04	dynamic modes.....	2.32	Error messages.....	3.07
Driver Display modes.....	3.04	reactivating.....	2.34	Exhaust.....	2.12
Driver Display overview.....	2.05	Electronic user manual.....	3	temperature monitoring.....	2.12
Driving abroad.....	6.47	Emergency Equipment		Exit lighting.....	5.13
Driving away.....	2.10	emergency equipment safety.....	6.12	Exterior lighting.....	1.48
Driving in winter.....	2.52	manual door release key holder.....	6.15	Exterior mirrors.....	1.46
Driving precautions.....	6.38	service cover release tool.....	6.14	heating.....	1.47
Driving Safety Systems		Emergency equipment safety.....	6.12	memory.....	1.31
General.....	2.29	Emergency fuel filling funnel.....	6.14	mirror automatic fold.....	1.47
Dynamic ESC modes.....	2.32	Engine.....	2.08	mirror fold.....	1.47
Dynamic Headlamps.....	1.51	Eco Start-Stop System.....	2.09	reverse dip.....	1.47
E		immobiliser.....	1.24	Extinguisher.....	6.15
Economical driving.....	2.11	power output.....	7.04	Eye - towing.....	6.14
		running in.....	2.47		
		starting.....	2.08		

Index

F

Features

12 V socket.....	5.17
cup holders.....	5.16
electrochromic roof.....	5.13
entry lighting.....	5.13
exit lighting.....	5.13
interior lighting.....	5.12
stowage compartments.....	5.14
sun visors.....	5.17
USB sockets.....	5.18
Filling with fuel.....	2.49
Fire extinguisher.....	6.15
First aid kit.....	6.13
Fluid - brake.....	7.17
topping up.....	6.10
Fluid - power steering.....	7.16
topping up.....	6.09
Folding Driver Display	
left-hand display overview.....	2.05
right-hand display overview.....	2.06
Folding Driver Display deployment.....	3.04
Folding Driver Display folding.....	3.04
Folding Driver Display modes.....	3.04
Folding Driver Display overview.....	2.05
Foot brake.....	2.08
Force limiters - seat belts.....	1.38
Front air bags.....	1.39

Front luggage compartment.....	1.14
unlocking and opening.....	1.14
Fuel.....	2.49
funnel.....	6.14
quality.....	2.50
safety.....	7.15
tank.....	7.15
Fuel level display.....	3.21
Fuel range display.....	3.21
Funnel - fuel.....	6.14
Fuse box	
battery.....	6.24
main.....	6.19
secondary.....	6.22
Fuses	
battery fuse box.....	6.24
main fuse box.....	6.19
replacement.....	6.19
secondary fuse box.....	6.22
G	
Garage door opener.....	4.24, 4.49
erasing programmed garage door	
openers.....	4.50
overview.....	4.49
programming.....	4.49
settings.....	4.24
Gearbox.....	2.16

gear positions.....	2.16
gearshift paddles.....	2.19
kickdown.....	2.17
manual/automatic mode.....	2.18
oil topping up.....	6.06
Gear position indicator.....	3.19
Gear positions.....	2.06
Gear ratios.....	7.06
Gear shift indicator.....	2.11
General.....	2.29
General settings.....	4.08
Genuine McLaren Parts and Accessories	
overview.....	7.02
Glossary - technical.....	7.18
Ground clearance.....	5

H

Handling control.....	2.22
Hazard warning lamps.....	1.53
Headlamps.....	1.50
Dynamic Headlamps.....	1.51
flash.....	1.51
main beam.....	1.51
Heated mirrors.....	1.47
Heated rear window.....	5.11
Heated seats.....	5.10
Hill hold control.....	2.31
Horn.....	1.36

Index

Hot Evac - climate control.....5.06

I

Identification number - vehicle.....7.03

Ignition - switching on.....2.03

Immobiliser.....1.24

Increasing vehicle ground clearance.....1.57

Increasing vehicle ride height.....1.57

Individual unlock settings.....1.09

In gear speeds.....7.06

Inspecting tyres.....6.37

Inspecting wheels.....6.37

Installing the service cover.....1.12, 1.13

Instrument cluster display.....3.04

Instruments.....3.18

 cleaning.....6.43

 Comfort mode.....3.18

 display.....3.18

 display messages.....3.11

 display window.....3.18

 driver display deployment.....3.04

 driver display folding.....3.04

 driver display modes.....3.04

 driver display overview.....2.05

 Electronic Stability Control mode

 display.....3.19

 fuel level display.....3.21

 fuel range display.....3.21

 gear position indicator.....3.19

 handling and powertrain display.....3.19

 left-hand display overview.....2.05

 oil temperature display.....3.20

 overview.....3.02

 right-hand display overview.....2.06

 shift lights.....3.02

 speedometer.....3.03

 sport mode.....3.18

 tachometer.....3.02

 track mode.....3.18

 trip computer.....3.06

 vehicle info.....3.07

 water temperature display.....3.20

Interchanging wheels.....6.39

Interior accessory power socket.....5.17

Interior lighting.....5.12

 ambient lighting.....5.12

 courtesy lighting.....5.12

Interior mirror.....1.46

Interior motion sensor.....1.25

Introduction.....2

 overview.....4.06

 Stored data.....6

J

Jacking the vehicle.....6.44

Jump starting.....6.17

K

Key fob.....1.04

 battery replacement.....6.32

 discharged battery.....1.06

 entry.....1.04

 stowing.....1.06

Keyless entry.....1.04

Kickdown.....2.17

Kit - first aid.....6.13

Kit - tyre repair.....6.39

L

Lamps - side.....1.50

Launch control.....2.26

Lifting points - vehicle.....6.44

Lighting

 ambient lighting.....5.12

 automatic control.....1.50

 courtesy lighting.....5.12

 daytime running lamps.....1.52

 dipped beam.....1.50

 direction indicators.....1.53

 Dynamic Headlamps.....1.51

 exterior.....1.48

 hazard warning lamps.....1.53

 headlamp flash.....1.51

 interior.....5.12

Index

main beam.....	1.51
parking lights.....	1.54
rear fog lamp.....	1.52
sidelamps.....	1.50
switch.....	1.50
Light settings.....	4.16
Light switch.....	1.50
Limphone.....	2.11
Locking.....	1.07
automatic.....	1.11
from inside.....	1.09
from outside.....	1.07
mislock.....	1.08
LT Super-Lightweight CF Seat.....	1.33
adjustment.....	1.33
Luggage compartment	
closing.....	1.14
equipment.....	6.12
front.....	1.14
manual opening.....	6.29
opening - discharged battery.....	6.29

M

Main beam.....	1.51
Main fuse box.....	6.19
fuses.....	6.19
Main instruments overview.....	2.05

Manual door release	
key holder.....	6.15
Manual door release key holder.....	6.15
Manual mode - climate control.....	5.05
Manual mode - transmission.....	2.18
Manual seats.....	1.28
backrest rake adjustment.....	1.28
forward and rearward adjustment.....	1.28
height adjustment.....	1.28
Manual test - Airbrake.....	2.37
Manual unlocking.....	6.27
McLaren Assistance.....	6.45
in the event of a breakdown.....	6.45
McLaren Infotainment System	
AUX.....	4.36
bluetooth audio.....	4.36
bluetooth phone settings.....	4.16
cameras.....	4.24
connecting an external device.....	4.34
connection settings.....	4.13
contacts.....	4.30
copyright.....	4.04
device pairing.....	4.26
ending a call.....	4.30
garage door opener.....	4.24
general settings.....	4.08
in-call options.....	4.30
introduction.....	4.06
light settings.....	4.16

making a call.....	4.28
media controls.....	4.33
navigation.....	4.22
other information.....	4.04
overview - media.....	4.32
overview - navigation.....	4.37
overview - phone.....	4.25
overview - radio.....	4.41
radio & media settings.....	4.15
radio controls.....	4.41
radio data system.....	4.42
receiving a call.....	4.29
regional settings.....	4.10
safety.....	4.37
setting a destination.....	4.39
settings.....	4.08
sound settings.....	4.14
storage.....	4.35
system controls.....	4.04
USB and iPod.....	4.34
using navigation.....	4.38
voice recognition.....	4.51
McLaren Infotainment System (MIS)	
Compliance.....	8.02
Conformity Information.....	8.02
McLaren Track Telemetry	
drive.....	4.44
editing a track.....	4.48
ending your session.....	4.46

Index

exporting telemetry data.....	4.47	
importing telemetry data.....	4.47	
opening the application.....	4.43	
overview.....	4.43	
reviewing you data.....	4.46	
setup.....	4.44	
Media.....	3.10	
AUX.....	4.36	
bluetooth audio.....	4.36	
connecting an external device.....	4.34	
media controls.....	4.33	
overview.....	4.32	
storage.....	4.35	
USB and iPod.....	4.34	
Media USB sockets.....	5.18	
Messages.....	3.07	
Microwave Window.....	5.02	
Mirror		
automatic exterior mirror fold.....	1.47	
exterior.....	1.46	
exterior mirror fold.....	1.47	
heating.....	1.47, 5.11	
interior.....	1.46	
memory.....	1.31	
reverse dip.....	1.47	
Mirrors		
vanity.....	5.17	
Mislock.....	1.08	
Motion sensor - interior.....	1.25	
N		
<hr/>		
Navigation.....	3.10, 4.22	
overview.....	4.37	
safety.....	4.37	
setting a destination.....	4.39	
using navigation.....	4.38	
Notification lights.....	2.04	
O		
<hr/>		
Odometer.....	3.06	
Oil - engine.....	6.04	
capacity.....	7.15	
checking.....	6.04	
level.....	6.04	
level warnings.....	6.04	
specification.....	7.15	
status.....	3.08	
temperature display.....	3.20	
temperature warnings.....	6.06	
top up.....	6.05	
Oil - gearbox.....	6.06	
Opening a door		
from inside.....	1.09	
from outside.....	1.06	
Opening and closing the vents		
central dashboard air vent.....	5.10	
dashboard air vents.....	5.10	
Opening the backlight.....		1.20
Opening the roof.....		1.16
Opening the roof with the key fob.....		1.17
Opening the tonneau cover.....		1.20
Opening the windows.....		5.02
Operating temperatures - vehicle.....		7.04
Other information.....		4.04
Outside temperature display.....		3.04
Owner documentation.....		5.17
P		
<hr/>		
Panic alarm.....		1.54
Parking brake.....		2.06
Parking days.....		2.02
Parking lights.....		1.54
Parking sensors.....		2.12
Parts		
overview.....		7.02
Parts and Accessories		
overview.....		7.02
Passengers - child.....		1.43
Performance shift cue.....		4.19
Phone.....		3.09
contacts.....		4.30
Device pairing.....		4.26
ending a call.....		4.30
in-call options.....		4.30
making a call.....		4.28

Index

overview.....	4.25
receiving a call.....	4.29
Power output.....	7.04
engine.....	7.04
Power steering fluid.....	7.16
topping up.....	6.09
Powertrain control.....	2.24
Precautions - driving.....	6.38
Pressures - tyre.....	6.38, 7.13
Products - service.....	7.15
Puncture repair kit.....	6.39

R

Racing seats.....	1.29
adjustment.....	1.29
Radio	
overview.....	4.41
radio controls.....	4.41
radio data system.....	4.42
Radio & media settings	
overview.....	4.15
Rain sensor.....	1.55
Ratios - gear.....	7.06
Reading lights.....	5.12
Rear fog lamp.....	1.52
Rear luggage	
stowage.....	5.15
Rear spoiler.....	2.34

Rear view camera.....	2.14
Rear Window	
heating.....	5.11
Recirculation mode - climate control.....	5.08
Recommended fuel quality.....	2.50
Recovery of your vehicle.....	6.46
Refuelling.....	2.49
Regional settings.....	4.10
Removing the service cover.....	1.11, 1.13
Replacement battery.....	6.45
Replacing	
bulbs.....	6.26
fuse.....	6.19
key fob battery.....	6.32
vehicle battery.....	6.45
wiper blade.....	6.33
Restraint system.....	1.39
child.....	1.43
KISi child seat function.....	1.44
supplementary.....	1.39
Retractable Roof.....	1.15
Rev counter.....	3.02
Reverse mirror dip.....	4.18
Road speed limit.....	4.21
Roof.....	1.15
closing.....	1.17
closing with the key fob.....	1.18
opening.....	1.16
opening with the key fob.....	1.17

Running in.....	2.47
-----------------	------

S

Safety.....	1.37, 5.02
air bags.....	1.39
air bags Out Of Position (OOP).....	1.42
air bag system modification.....	1.39
battery.....	6.16
fuel.....	7.15
mirrors.....	1.46
replacement of air bags.....	1.39
seat belts.....	1.37
seats.....	1.27
safety equipment.....	6.12
Sealant - tyre.....	6.13
Seamless Shift Gearbox.....	2.16
gear positions.....	2.16
gearshift paddles.....	2.19
kickdown.....	2.17
manual/automatic mode.....	2.18
Seat belts.....	1.37
force limiters.....	1.38
safety.....	1.37
tensioners.....	1.38
wearing.....	1.38
Seat belt warning light.....	1.38
Seats	
backrest - electric rake adjustment....	1.30

Index

backrest - manual rake adjustment.....	1.28
electric adjustment.....	1.29, 1.29
electric backrest rake adjustment.....	1.30
electric forward and rearward adjustment.....	1.29
electric height adjustment.....	1.30
electric seat and mirror memory.....	1.31
electric seat lumbar adjustment.....	1.31
heating.....	1.33, 5.10
LT Super-Lightweight CF Seat adjustment.....	1.33
manual adjustment.....	1.28
manual backrest rake adjustment.....	1.28
manual forward and rearward adjustment.....	1.28
manual height adjustment.....	1.28
routing seat adjustment.....	1.29
safety.....	1.27
stowage pocket.....	5.15
Seat stowage pocket.....	5.15
Secondary fuse box.....	6.22
fuses.....	6.22
Sensors	
interior motion.....	1.25
parking.....	2.12
Service and Warranty.....	5.17
Service cover.....	1.11, 1.13
Closing.....	1.12, 1.13
Opening.....	1.11, 1.13
Service cover release tool.....	6.14
Service interval.....	3.08
Service products.....	7.15
Settings	
overview.....	4.08
Settings - individual unlock.....	1.09
Setting up warning triangle.....	6.13
Shift lights.....	3.02
Side head air bags.....	1.40
Sidelamps.....	1.50
Silent door lock.....	4.20
Snow socks.....	2.52
Sound settings.....	4.14
Specification - engine oil.....	7.15
Specifications.....	7.04
Speedometer.....	3.03
Speeds - in gear.....	7.06
Spoiler.....	2.34
START/STOP button.....	2.03
Starting and driving	
foot brake.....	2.08
gear positions.....	2.06
instruments and warning lights.....	2.03
main instruments.....	2.05
notification lights.....	2.04
parking brake.....	2.06
starting the engine.....	2.08
switching on the ignition.....	2.03
warning lights.....	2.03
Starting the engine.....	2.08
discharged key fob battery.....	6.28
Steering column	
electrical adjustment.....	1.34
manual adjustment.....	1.34
Steering wheel	
electrical adjustment.....	1.34
horn.....	1.36
manual adjustment.....	1.34
Stopping the engine.....	2.09
Stored data.....	6
Stowage	
rear luggage.....	5.15
tonneau area.....	1.23
Stowage compartments.....	5.14
centre console.....	5.14, 5.15
door.....	5.15
seat.....	5.15
Stowing the key fob.....	1.06
Summer tyres.....	7.12
Sun visors.....	5.17
Supplementary Restraint System.....	1.39
Surround view cameras.....	2.15
Switching air conditioning on/off.....	5.06
Switching on the ignition.....	2.03
Switch - lighting.....	1.50
Symbols.....	4
SYNC mode - climate control.....	5.05
System controls.....	4.04

Index

T	
Tachometer.....	3.02
Technical data.....	7.04
engine.....	7.04
gear ratios.....	7.06
speeds - in gear.....	7.06
turning circle.....	7.13
tyre pressures.....	7.13
vehicle dimensions.....	7.07
vehicle operating temperatures.....	7.04
vehicle weights.....	7.10
wheel and tyre sizes.....	7.12
Technical glossary.....	7.18
Temperature - climate control.....	5.07
Temperature display.....	3.04
Tensioners - seat belt.....	1.38
Tonneau cover.....	1.20
closing.....	1.21
opening.....	1.20
operation.....	1.20
Tonneau stowage.....	1.23
Tools.....	6.12, 6.14
Topping up.....	6.04
brake fluid.....	6.10
coolant - Coupe.....	6.07
coolant - Spider.....	6.07
engine oil.....	6.05
gearbox oil.....	6.06
power steering fluid.....	6.09
windscreen washers.....	6.11
Tow-away protection.....	1.25
Towing.....	6.46
eye.....	6.14
Track driving.....	5
Track use.....	2.48
Traction control system.....	2.32
Triangle - warning.....	6.12
Trofeo R tyres.....	6.37
Turning circle.....	7.13
Tyre monitoring.....	3.07
Tyre pressures.....	6.38, 7.13
Tyres.....	6.36
asymmetric.....	6.36
inspecting.....	6.37
markings.....	6.36
monitoring system.....	2.38
pressure monitoring.....	2.38
pressures.....	6.38, 7.13
repair kit.....	6.39
sealant.....	6.13
summer.....	7.12
temperature monitoring.....	2.40
Trofeo R.....	6.37
winter.....	7.13
Tyre type.....	4.20

U	
Unlocking and opening the front luggage compartment.....	1.14
Unlocking - discharged battery.....	6.27
Unlocking from inside.....	1.09
Unlocking from outside	
key fob.....	1.04
keyless.....	1.06
Upper speed limit.....	2.45, 2.46
setting.....	2.45, 2.46
USB sockets.....	5.18
media.....	5.18

V	
Valet mode.....	4.20
Vanity mirrors.....	5.17
Vehicle dimensions.....	7.07
Vehicle electrical status.....	2.02
Vehicle identification.....	3.09
Vehicle identification number.....	7.03
Vehicle info.....	3.07
battery status.....	3.08
error messages.....	3.07
oil status.....	3.08
service interval.....	3.08
tyre monitoring.....	3.07
vehicle identification.....	3.09

Index

vehicle lift.....	1.57	Volumetric alarm.....	1.25	Wheel - steering	
lower.....	1.58			electrical adjustment.....	1.34
operation.....	1.57			manual adjustment.....	1.34
raise.....	1.58			Window demisting - climate control.....	5.07
Vehicle lifting points.....	6.44	W		Windows	
Vehicle Recovery.....	6.45, 6.45	Warning - engine oil level.....	6.04	anti-trap protection.....	5.03
Vehicle settings		Warning - engine oil temperature.....	6.06	microwave window.....	5.02
auto alarm.....	4.19	Warning light		opening and closing.....	5.02
automatic door locking.....	4.19	Anti-lock Braking System.....	2.30	Safety.....	5.02
automatic mirror folding.....	4.19	brakes.....	2.08	Windscreen washers.....	6.11
door unlock.....	4.20	engine.....	2.11	Windscreen wipers.....	1.55
Performance shift cue.....	4.19	seat belt.....	1.38	rain sensor.....	1.55
reverse mirror dip.....	4.18	Supplementary Restraint System.....	1.42	single wipe.....	1.55
Road speed limit.....	4.21	Warning lights.....	2.03	wash/wipe.....	1.56
silent door lock.....	4.20	Warning triangle.....	6.12	wiper blade replacement.....	6.33
tyre type.....	4.20	Washers.....	6.11	wiper modes.....	4.21
valet mode.....	4.20	windscreen.....	6.11	wiper sensitivity.....	4.21
wiper modes.....	4.21	Washing.....	6.41	Winter driving.....	2.52
wiper sensitivity.....	4.21	exterior.....	6.41	Winter tyres.....	7.13
Vehicle speeds.....	7.06	wheels.....	6.41	Wiper blade replacement.....	6.33
Vehicle starting.....	2.08	Water temperature display.....	3.20	Wiper modes.....	4.21
discharged key fob battery.....	6.28	Wearing seat belts.....	1.38	Wiper sensitivity.....	4.21
Vehicle use.....	2.47	Weights.....	7.10		
Vehicle washing.....	6.41	Wheel and tyre sizes.....	7.12		
Vehicle weights.....	7.10	Wheels.....	6.35		
Vents		inspecting.....	6.37		
central dashboard.....	5.10	interchanging.....	6.39		
dashboard.....	5.10	Wheels and tyres.....	6.35		
Voice Recognition.....	4.51	Wheel sizes.....	7.12		

